

Tulip Pyramid—Copy and Identity

Jing He



Tulip Pyramid

—

Copy and Identity

Jing He





8

Introduction

10

Chapter 1

My identity: between the unique and the general

16

Chapter 2

Why are there so many counterfeits in China?

2.1

30 years of high-speed economic growth

2.2

Copy and counterfeit in mass production

22

Chapter 3

Resisting and learning from identity

3.1

Copying as a tool of rebellion

3.2

Buying thoughts

30

Chapter 4

Transformation—copying as a power of creativity

4.1

Transformation—about errors and modification in copying

4.2

A blurred boundary—the transformation into Delftware and the Tulip Pyramid



42

Chapter 5

Hybrid: a design method inspired by the reality of copying in China

5.1

Communism of form and personality

5.2

Conflicts and problems

48

Chapter 6

Design method and practice

6.1

Combination of collective work and various personalities

6.2

The process of collaboration and creation

6.2.1

Unexpected transformation

6.2.2

Copy the functionality

6.2.3

Copy the surface

6.2.4

The ownership/authorship

6.2.5

Using others' language as material

76

Conclusion

78

Appendix

81

Bibliography

Introduction

My research began, like many do, with a question concerning my identity. As a Chinese designer, I am frequently asked whether my work reflects my Chinese identity. I wonder: What does that mean? What is Chinese design? And in what way does it differ from design made by people with other nationalities? In Chapter 1, I explore the intentions behind these questions and I describe how Chinese designers are anxious about their identity, and, as one of them, I share this anxiety.

I then explain how I think this anxiety is contingent on the phenomenon of copying in the field of design in contemporary China. China has undergone fast economic growth in the past 30 years, and the quick changing of life and culture triggered a crisis of identity. Large factories producing counterfeits of 'original' designs are in large part responsible for China's economic growth. In Chapter 2, I research the historical, political, economic and cultural reasons behind the phenomenon of copying in China. Considering that the design profession is one of creativity, it should not come as a surprise that Chinese designers are sensitive to the subject of copying; it supposedly conflicts with the creativity of the profession. As such, Chinese designers are facing the fact that a large amount of counterfeits have been produced in China, and are left questioning their identity as designers.

In a mass-production industry, copying is an important method, thus people need intellectual property laws to protect their investment and profits. In Chapter 3, I will outline some examples that illustrate the tension between originality and copying in the Chinese design arena. Think for instance about the ongoing legal and cultural conflict between Joyme and IKEA. Or the Chinese acquisition of the Bauhaus collection, in an attempt to transform 'Made in China' to 'Designed in China'. To understand the significance of copying in China, despite any critical connotation that might arise, I, as a designer, try to incorporate this reality in my work. I wonder what my experience growing up in a rapidly changing cultural and economic environment amidst endless copycatting means to me? How does it relate to my profession, my work, and its Chineseness (if there is any)?

To answer these questions, I started with a general question: What is identity? I think that one's identity cannot be separated from where and how one is raised. I question the notion of identity in the system of capitalism, where one's identity probably consists of a collection of products. Thousands of mass-produced products and advertisements are designed to encourage people to purchase the commodities that match many sorts of designed identities. Thus in design, what does 'Chinese' mean? Is it a sort of flavor, taste, style or commercial strategy?

Secondly, in my design, I question the notion of originality. As China grew to be the world's second-largest economy, counterfeiting became an important subject. In recent decades, products that are manufactured in China are familiar in daily life all over the world, but 'Made in China' also means 'cheap' and 'low-quality'. Added to this is a huge amount of products that have been produced in China without the label of 'Made in China', and these are considered 'fakes'. But how to define 'fake'? Is copying always a negative word? Can a designer learn from copies and fakes, while still finding the practice somewhat deplorable? I believe facing the confusion of my cultural background is an important step to assess my identity as an individual designer; a design method may come from the careful observation of the chaos.

Therefore, I believe that one's identity reflects where and how one grew up, and I want to learn from the phenomenon of copying in China instead of denying it. I aim for a design method inspired by the practice of copying in Chinese culture. In the last Chapter, I describe my own design proposal where I take copying and being copied as a natural process and create an opportunity to copy the project itself. Although the project is not a famous design that will be copied by others, copying has already taken place inside this design project: A Tulip Pyramid created and transformed by the practice of copying.



Chapter 1

My identity: between the unique and the general

I was born in 1984 in Kunming, a city in the southeast of China, and I started to study in the Netherlands in 2009. During my stay in Europe, I met both European and Chinese people who asked me if there is something specifically Chinese about my work. When I asked the reasons behind those questions, the answers were quite revealing; they didn't find anything particularly 'Chinese' in my work. I was surprised that this common reaction to my designs came from both Dutch and Chinese who work in the same field as I do. Once a Chinese designer told me directly that my works looked very 'western', and I didn't know whether that was a compliment. These experiences brought me to question what being 'Chinese' is, something which has never been a topic in my work. Apart from the question of whether my work is actually more 'Chinese' or 'western', I am more curious about what people expect to see in my work: Which images fit with the image of China in their minds?

At the same time, I recognize the subtext of the questions about my identity, in the case of the Chinese man, it reads: 'Why do you (we, Chinese) want to be the same as them (European)?' I see different, albeit related, fears here — a fear of perpetuating the practice of copying, and, as a result of this, a fear of losing one's Chinese identity. In this, I sympathize with the Chinese who share my profession. I understand their anxiety in the search for a Chinese identity in European discourse, especially since Chinese identity seems to be defined by European discourse. The phenomenon of copying foreign designs in contemporary Chinese society is at the root of our issues with identity, and I can explain this using one of my own experiences.



fig.1



fig.2

fig.1-2
The photos of Park 1903, Kunming, China, kungfumonkey.com

Last year when I came back to my hometown for a holiday, my father suggested taking a walk to the brand new community near our apartment after dinner. 'It is very funny to see the fake Arc de Triomphe de l'Étoile there,' he said. This Arc de Triomphe is constructed with glass facades and with colorful LED lighting inside. Although I had heard a lot about similar copies of European historical architecture in China, it was my first time visiting such a place in my own hometown. This community, called Park 1903, is, as far as Chinese communities go, considered a very big one. It includes a park, shopping malls, residential blocks, and office buildings. It is plain to see that the purpose of the real estate developer was to build in a 'European style' [fig.1](#). Similar to the Chinoiserie in Europe in 17th and 18th centuries, this European style in China is a mixture of Baroque, Gothic and Chinese imagination of European tradition without any specific origins, thereby sometimes evoking the image of a Disneyland-like reality.

Besides the modern version of the Arc de Triomphe de l'Étoile [fig.2](#), I also visited a church with sharp tops and many European-style classical sculptures. Although reminiscent of classical architecture in style, these sculptures are not made of marble, and the church is definitely not built for religious purposes. In fact, both are constructed as a style of image [fig.3-5](#). The church will undoubtedly be a popular place for wedding photography, and the sculptures speak of a European sculpting tradition. For the Chinese, mimicking European architecture and art, signifies that Park 1903 is an expensive and high-class community.



fig.3



fig. 4-5
Two sculptures in Park 1903, Kunming, China
Photos from the brand called *Suares*, which is the local factory that produces these sculptures.
The material in their description is '仿汉白玉' (Imitation of white marble).

Park 1903 is not the only European style community in the area, but it is the biggest one. Although they all look like a film set or an image from a kitschy postcard, they are built with the intention of becoming part of people's real life horizon.

The community just started offering properties for sale, families will move in, kids will grow up there. The local language, culture and lifestyle will change because of the style of the buildings into a hybrid scene. Although it is hard to say what kinds of traditions rule there, I am not an outsider to this phenomenon and I find it difficult to keep a professional distance with these ever changing scenes. One of my own deeply-felt experiences is that I find it impossible to be nostalgic as most of the places of my childhood have already changed into something else. It always takes time for me to adapt to something new in my hometown when I go back for a holiday every year. I feel like a stranger both in my hometown and in the Dutch town I am currently living in, but at the same time I am familiar with the similarities of their urban facilities and systems. In this sense there seems to be a connection between myself and this local version of the Arc de Triophe de l’Etoile: Both of us are part of the hybrid identity constructed in China.

As I was walking among these copies of European architecture, I felt something beyond funniness in Park 1903. I used the key words ‘Chinese European town’ in a search engine, and it showed about 111,000,000 results. Some of the articles on the first page began with the description of the phenomenon of copying in China. For example, one report by Ruth Morris from the BBC called *Why China Loves to Build Copycat Towns* started with ‘China is well known for its pirated DVDs and fake iPhones, but this “copycat culture” extends to architecture too—with whole towns sometimes replicated’. It seems that copying is a defining characteristic of contemporary China.

Dr. Meng Li from the Philosophy Department of Peking University once pointedly argued in an interview that the Chinese currently live in a society that is ‘more modernized’ than modernity. He said,

‘In a sense, the Chinese live in a “super modern” society, where he (Chinese) lives in an endless stream of conflict and anxiety. He lives in a “pre-life” — a never-ending progress, a middle ground— so that he can start his “real life” in a dreamland. In this way, he cannot make any sense of his current and previous experience’.⁹ Li is suggesting here that we (the Chinese) are living without an awareness of traditions that can help us ‘digest’ the non-stop clash and anxiety of modernity. Contemporary Chinese generally feel that they are living in a temporary stage of history. Our lives are always preparing us for the future, not for the present.

⁹ Study of the West with the Problem of China. An interview with Meng Li.



Chapter 2

Why are there so many counterfeits in China?

As a Chinese designer, puzzled about identity, I find it necessary to understand the historical, political, economic, and cultural reasons behind the phenomenon of copying in China.

Why there are so many counterfeits in China? This is a big question when I began studying design. As I explained above, it is not just a theoretical question, it relates to my real experience as well. I grew up with music from lots of pirate cassettes and disks, before downloading was the rage. The cheap price was attractive and it was hard to find legal copies in my Chinese town in 90's. One major issue with pirating is, of course, the matter of copyright. The economic growth in China was largely caused by a significant lack of copyright laws. People's awareness of copyrights grew in accordance with the fast economic development of the past 30 years, resulting in some interesting discussions about intellectual property in the field of design.

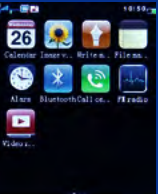

2.1

30 years of high-speed economic growth

The biggest concern for many foreign companies while making profits from Chinese industrial labor is the mass production of fakes. Kering, the French luxury goods holding company, owner of brands such as Gucci, Bottega Veneta, Saint Laurent, complained that in 2014 37,000 counterfeit Gucci bags were sold on *taobao.com* in one month from 2,731 different shops. *Taobao.com* is the biggest Chinese shopping site and it invented the largest e-shopping day in the world, Double Eleven (11 November). The turnover during the Double Eleven in 2015 was over 91.2 billion RMB (approx. 13.3 billion Euro). However, in January 2015 the State Administration for Industry and Commerce of China released a survey showed that only 37% of the goods it examined on *taobao.com* were authentic, including cellphones, toys, garments, make-up products and fertilizers. Although the spokesman of *taobao.com* argued to discredit the accuracy of the survey, it is no surprise that media like the Financial Times called the Double Eleven 'China's biggest day for fake goods'. Jack Ma, the founder of *taobao.com*, attempted to suppress the sale of fake goods, but he could not get rid of the problem. 'In fact, Ma sees his issue with bogus goods as a direct outgrowth of China's economic ascent', wrote the business journalist Michael Schulman in Forbes magazine.

China spent 38 years grow from an old Soviet type of economy into the second largest economy in the world. In 1978^e, the Communist Party of the People's Republic of China started economic reforms called 'Socialism with Chinese characteristics', which introduced the market principle to replace the Soviet economic model. These economic reforms allowed the country to open up its markets to foreign investments, and allowed entrepreneurs to

^e According to wikipedia's list of GDP's in 2010.

start private businesses. After that, 'Made in China' became a common mark, to be found on most of the ordinary products all over the world. China is now famous for its mass-production, thanks to its cheap labor and efficient producing.

After the economic reforms of 1978, manufacturing industries have sprouted up in the south of China. There are two types of manufacturers: The Original Design Manufacturer (ODM) and the Original Equipment Manufacturer (OEM). An OEM functions as a third party, assembling and producing products by licensing a brand name, without ownership of the original design or ideas. For example, a famous OEM called Foxconn produces Apple's designs. Apple designs and Foxconn makes. [fig.6](#)



[fig.6](#)
Assembly line of Foxconn
img.chinaluxus.com

When China joined the Universal Copyright Convention in 1992, it was much later than the economic reforms. Because the government didn't pay attention to the protection of Intellectual Property (IP) at the beginning of reforms, the market for counterfeit products was booming, paced according to the economic development of the country. The OEM gets the licensing agreement, the designs and the materials directly from the brand, but it also creates a grey area between authenticity and fake. Some employers may produce extra goods without trademarks and sell them under the table. The extra goods from an OEM are always much cheaper and claim to have the same quality as the authentic ones. These kinds of goods were popular in local markets, because they were unique, even though they were produced in China, and not all of them were for the Chinese market. It led some small factories to copy these goods and claim they were leaked from an OEM.

The history of development in manufacture brings with it the problem of authenticity. This is not to be confused with art forgery, because there you have the duality of the original and the copy, and the originality depends on the uniqueness of the first creation of the work. Mass production is inherently about copying. In fact, the goal of industrial manufacturing is to mimic a prototype as closely as possible, and reproduce that result. As a result, an Intellectual Property (IP) law was deemed necessary to cease illegal copying. IP deals with copyrights, trademarks, and patent law. It does not, however, protect the idea behind a product. 'Ideas cannot be owned, because they are intangible, but the original expression of an idea can be owned when it is tangible, material, fixed,' according to Marcus Boon in his book *In Praise of Copying*. As such, IP law still allows the copying of products without patent protection, and in a capitalistic market, being original is not as important as turning a profit. Technology enables us to produce efficiently and accurately, and it is very possible that two products with exactly the same appearance are produced by same factory, but one of them will be a fake because it contravenes with IP protection.

Companies choose manufacturers depending on the balance of quality and cost. In essence, profitability leads the decision. When in 2010 the basic salary of a Chinese worker rose from 131 euro to 150 euro per month, many foreign companies stopped their contracts with Chinese manufacturers.⁹ Nike, for instance, was the first company to leave China for manufacturers in South-east Asian countries like Vietnam and Thailand, which provide cheaper labor and lower cost. Chinese manufactures were under pressure to reduce cost. In 2010, there were reports

that 14 workers in Foxconn had committed suicide. The loss of these young lives caused the society to think about the conditions and cost of Chinese factories.

Basically, there are two ways keep up competitiveness in a market in this difficult situation for Chinese manufacturers. One is to make fakes, avoiding the cost of research and licensing to keep the price of the products low. Another is to design new products to get more value from a brand. Some Chinese entrepreneurs and intellectuals realized the crisis came from a lack of ideas and designs, and they started to think about how to change 'Made in China' into 'Design in China'. But how to do that?

⁹ As reported by The China Labor Bulletin.



Chapter 3

Resisting and learning for identity

The mass production of cheap and low quality goods for the global market has brought China considerable wealth in the past 30 years, but it has also created a common image of China: that Chinese people are not creative. It is a common perception that they are good at copying but not at critical thinking and that they cannot think outside of the box. In this chapter, I will give two different examples of Chinese entrepreneurs and intellectuals who, under the same pressure of this 'identity crisis', have tried to counter this image of Chinese stereotyping. The first example is the new Chinese furniture brand Joyme, [fig. 7.1](#) which which started as IKEA's factory but then became a brand copying IKEA's designs. Joyme adopted copying as a tool to compete with IKEA, in the Chinese market. Intellectuals of a design academy in the south of China tried another approach to remove the image of China as the copycat. They achieved this by buying a large design collection from Torsten Bröhan, called the Bauhaus Collection. It should be noted that both these examples have a paradoxical characteristic; in order to subvert the image of the Chinese copycat, both Joyme and the China Academy of Art (CAA), are, in fact, copying. This exemplifies the tenacity of copying as a Chinese practice. [fig. 7.2.1-2](#)



[fig. 7.1](#)
Logo of IKEA and Joyme



[fig. 7.2.1](#)
Joyme advertisement
[gome.com.cn](#)



[fig. 7.2.2](#)
IKEA,
The HEMNES series,
[pinterest.com](#)

Copying as a tool of rebellion

Paradoxically, since ideas do not or cannot receive legal protection, IP law encourages those who produce commodities to exaggerate the inevitable distortion of the idea as manifest in the actual object. And the result of this is the kitsch version of originality, 'thinking outside the box', that prevails in the marketplace today.

—Marcus Boon, *In Praise of Copying*

Chinese entrepreneurs were faced with a crisis when many foreign brands left China for southeast Asian countries, looking for cheaper producing costs. A large group of Chinese OEMs have closed down gradually since 2008.⁴ The owners of these OEMs realized that they were disadvantaged by the contracts with particular brands. For instance, in 2010, 300 OEMs sued Adidas because in their open-ended work contracts, Adidas had the right to terminate the contract at any time, without compensation. However, some factories had expanded their production equipment just before Adidas terminated the contract. The OEMs admitted that they signed these unfair contracts in the beginning because of fierce competition.

However, not every OEM buckled under economic pressure. Indeed, some even rebelled against the power of these foreign brands. One such example is IKEA and Joyme. IKEA began working with Chinese suppliers in the 1990's, and it now employs more than 300 OEMs.⁵ One of these OEMs was the predecessor to Joyme, a factory which worked for IKEA for 16 years before establishing an online store selling its own products. The company said they made the decision to leave IKEA in 2011 because they couldn't afford the low costs stipulated in the contract. The brand Joyme was founded in 2012. Its new store is not geographically close to IKEA, but Joyme's products are almost identical to IKEA's.

⁴ As reported by businessleaders.com

⁵ business.sohu.com

A spokesperson for IKEA says the company will take every possible legal measure to protect its intellectual property, and it will take legal action against anyone who has infringed on its IP rights. However, Joyme claims that IKEA only owns the IP rights of 30% of their products, and so they haven't done anything wrong. The president of Joyme has never denied the copying of IKEA, and said in an interview: 'There are many things worth learning from IKEA, and if you learn from someone it's inevitable that you will have similarities with them. We believe that after a while we will develop our own style'.⁶

⁶ Reported by Chinese news website, news.163.com

Ironically, the notion to imitate first and develop your own style later is also the strategy of IKEA as well. One of their best selling chairs, PÖÄNG, was designed by Noboru Nakamura in 1977. The material, form and structure are reminiscent of the Chair 406 designed by Alvar Aalto in 1939. IKEA changes the color and textile of the cushions every year to renew the style of the chair. Joyme seems to have extended this IKEA-tradition when they copied the chair's design from IKEA's model.

Copying and imitation are important strategies in commercial competition. In his book about management and business strategy, *Good Imitation to Great Innovation* (2012), Japanese economist Tatsuhiko Inoue argues that imitation is an important aspect of the methodology of a commercial business. Inoue suggests that imitation is not merely about copying products, but it is also a business methodology for entrepreneurs. In his observations enterprises can use two kinds of imitation as tools—one is for competition, and the other one is for innovation. He argues that following competitors in the same field is important, 'to avoid disadvantage in competition, companies make similar products in the same industry. Product similarity, in this sense, is a gesture to maintain a relative competitiveness.'

I realized that being original is not the aim in the business world, it is just one of the tools of staying ahead of the competition. 'Fake' in China is a powerful economic phenomenon in the transition to full participation in a global capitalist market. Chinese intellectuals and enterprises show different strategies to manage the phenomenon. Intellectuals at CAA are convinced that the solution to the phenomenon is by first learning design theory from Europe. Alternatively, local brands like Joyme use copying as a practical tool against its competitor and former boss IKEA.

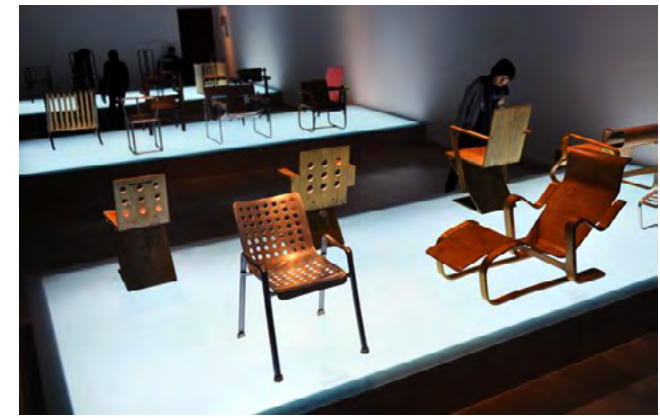

fig. 8
Bauhaus exhibition in China Academy of Art, 2011, art.ifeng.com

3.2 Buying thoughts

'It is the first time in China, even in Asia, that we bought the thoughts from the Western world,' Jiang Xu, the director of the CAA told a journalist when talking about the purchase of the Bauhaus Collection⁷. In the fall of 2010, the city council of Hangzhou, a wealthy city in the south of China, spent approximately 60 million Euros on the Bauhaus Collection, which includes more than 7000 design items from the Hamburg collector Torsten Bröhan. The city stored this collection in the CAA, one of the oldest academies of art in China. Hangzhou is not the only Asian city who wanted to purchase this collection; Seoul, the capital of Korea, also joined the competition. The Chinese finally won because they promised to build a new museum for the collection and they gave Torsten Bröhan the title of Honorary Professor of the CAA. In February 2014, CAA started to build the 'China International Design Museum', designed by the Portuguese architect Álvaro Siza. With 16.8 thousand square meters, and at a cost of approximately 16.7 million Euros in total, Jiang Xu claimed it will be the best design museum in Asia. He also claimed that because of the Bauhaus Collection it deserves the word 'international' in its title. Undoubtedly, this collection and the

⁷ newweekly.com, The use of the Bauhaus for Hangzhou. On a side note, while the collection is called 'Bauhaus', in actuality these are not just the works from the Bauhaus itself, but they also include designs from before and after Bauhaus.

upcoming museum will become the calling card of Hangzhou and CAA. [fig. 8](#)

This is only one example of a Chinese city's ambition to change 'Made in China' to 'Designed in China'. Additionally, this may help to stop the practice of copying in China. Jiang Xu said, 'It is meaningful that we have this collection in Zhejiang province (Hangzhou is its capital), where a lot of manufacturing industries are established. We are not only collecting these items, more importantly, we are going to study the relationship between design and daily life from them.' An institute and research lab of western design will be established in the new museum. The vice president of CAA, Jianming Song, said in an interview with German design medium Stylepark, 'Our aim is to study and understand the entire development chain of western—in this case German—design history.' And his words became more emotional when addressing Chinese media. He commented that MoMA and Pompidou had invited CAA to exchange the works with them, and he joked, 'Before, it was us asking things from grandpa now grandpa comes to ask us.' 'Grandpa' here is a metaphor for the Western world.

This urge to build up cultural self-confidence should come as no surprise if we look at Chinese modern history. 'China didn't have the chance to be part of the rulemaking of today's industrial system, we were only following in the recent 100 years,' said Jian Hang, the director of the upcoming design

museum. Hang is currently implementing plans to educate owners of factories and CEO's of companies in Zhejiang province with this collection. In his own words: 'to let them understand the value of this collection and the value of design in industry.'

Contrary to the very proud emotions of the Chinese, the German side was more surprised with a distinct critical undertone. After visiting the collection in CAA in Hangzhou in 2011, design expert Michael Erlhoff wrote a critical review on the design website Stylepark with the title *China and the Bauhaus as a Cabinet of Curiosities*. In this review he compared the exhibition of East Asian art in European museums with the Bauhaus Collection in the Chinese museum, suggesting that the former exhibitions are about 'illustrating colonial power and voyages, and possibly of participating in the exotic', the latter more about learning: 'In order to comprehend the historical reasons behind European design, but also in order to use it directly as a template and an example.' Erlhoff points out some mistakes in the exhibition, and accuses the Chinese of a lack of knowledge on the topic of design. This leads him to question if the Chinese will be able to put an end to the practice of 'learning by imitation' by studying design of the Western world. As he writes, 'all that remains is to hope that the Bauhaus will suddenly find itself in a position to better understand China's current problems in dealing with its own culture, with Western achievements and with design. But this will take time—something that nobody in China seems to have—in order to understand the reality of design, to translate this into studies and to implement it.'

Erlhoff's criticism, and the purchase itself, reflects the Chinese ambition to stop the recurring image of copycats. Whatever the future will hold, the common thing I see, both in the pride of the CAA and Michael

Erhoff's doubts, is a eurocentrist disposition. Intellectuals from CAA hold complicated attitudes toward the western history of design; they were anxious to show their commitment to rebrand the Chinese image, and at the same time wanted to prove themselves by gaining acceptance from the experts from the West, indeed, people like Michael Erlhoff. Erlhoff's critique could then be regarded as perpetuating the idea that the Chinese excel at producing but not at designing. While both are operating under the assumption that the West holds secrets that the Chinese are trying to reveal, in one aspect Erlhoff and I are of a like mind: acquiring a collection of western design history is hardly the key to solving China's current problem in the field.

Chinese development into modernity has been difficult. Impacts such as losing a series of wars with western countries in the early 20th century only added to these problems. Because of this, nationalism is a core topic when reviewing Chinese history. From the government to designers, there is an underlying mission to rebuild Chinese identity. For example, in 1997, the Chinese Communist Party started a movement called 'The History of Great Rejuvenation of the Chinese Nation'. The recently appointed Chairman Xi Jinping called it 'The Chinese Dream'. ^{fig. 9} However, the existence of a European-style community near my parents' apartment reflects a paradoxical reality in China; China excels at copying, which seems to be a problem for Chinese identity. I wonder, if there is a possibility that we can learn from this paradox instead of trying to disregard it?



fig. 9
One of the propaganda images of Chinese Dream, china.org.cn



Chapter 4

Transformation—copying as a power of creativity

Mimesis means copying, that is, presenting and producing something in a manner which is typical of something else.

—Martin Heidegger, *Nietzsche, volume 1*

In the last chapter, Joyme and IKEA, and the CAA's Bauhaus purchase, reflect the social transition of the economic system in modern China. This transition affected IP laws, business strategy, identity and other issues. This chapter focuses on design and aims to analyze the power of copying to develop creativity. As it stands now, the Chinese fear the public image of themselves as lacking creativity caused by copying. As I have outlined above, mass production depends on the principle of copying; seeing as imitation is an important business strategy, it is impossible not to copy. It seems that we are bound to copy and we must follow certain rules and laws.

However, as a Chinese designer, in my opinion creativity and identity are entrenched in what we have and are good at, one cannot look for identity by ignoring certain periods of one's history. First of all, the Chinese are good at copying. It is part of our identity, even when it is being denied. Looking back 3000 years, the ancient Chinese were already using copying technique. They used a section-mold casting technique to reproduce bronze ritual vessels.⁹ Acknowledging copying as part of Chinese identity, it can become a powerful creative tool. I believe creativity does not only come from studying the western design collection, but also comes from a historical understanding of copying as a practice that has led to transformative, and remarkably creative, designs. In this chapter I discuss how the tension between originality and copying can be a force for producing innovative designs.

⁹ As described by Lothar Ledderose in *Ten Thousand Things: Module and Mass Production in Chinese Art*, tracing casting methods in China as early as 1650 B.C. to 1050 B.C.

Dutch copying of Chinese porcelain, is the prime example of the creation of a new distinct design that has been copied from a different culture. This shows how it is possible to appreciate that copying can be a power of creativity. This is because it has two essential qualities: repetition and transformation. Consequently, it is through the process of repetition, that a transformation occurs.

4.1 Transformation—about errors and modification in copying

Copying can lead to transformation. Especially, when we take into consideration why copying is put into effect in the first place, primarily to change an original design to fit a new context or a new purpose. Here again Joyme provides a good example. This former OEM of IKEA copied IKEA in an eye-catching and controversial way—their stores and their products look very similar to IKEA's. However, as also noted by the business management journal ICEO, Joyme modified the products of IKEA so they adapted to Chinese every-day life. Joyme changed a sofa bed, for instance, which in IKEA's design was a two-person job, and altered it into a one-man operation. They also reduced the scale of many furniture items to fit the smaller living spaces in China. These small changes are hardly noticeable at first glance, but they reveal the advantage of copying designs by a local brand, because their designs are more sensitive to local consumers' demands. Granted, those little changes seem very mild transformations compared to the transition from Alvar Aalto's chair 406 to IKEA's POÄNG. [fig. 10.1-4](#)



[fig.10.1](#)
Alvar Aalto, Chair 406
[artek.com](#)



[fig.10.2](#)
IKEA POÄNG
[ikea.com](#)



[fig.10.3](#)
IKEA used to make
POÄNG with webbing.
[allthingscandinavian.wordpress.com](#)



[fig.10.4](#)
Joyme
[taobao.com](#)

However, the subsequent changes in Joyme's design, shows how every little change in the copying process is a transformative step.

In mass production the imitator also has the power to influence the original design. Take the cell phone as an example. Chinese factories that were producing fakes (unbranded) cell-phones, came up with an invention that allowed people to use two SIM cards in one cell phone. Later on, a number of big brands started imitating this function in their products, like Samsung. Aesthetic choices are also sometimes based on a fake version. The fake golden iPhone first appeared on the market around 2008. It was only in 2013 that Apple started to produce their own golden version, which became a popular color in their product line. Tracing similar processes allows us to acknowledge various transformations in many designs that have generated unique outcomes.

A transformation does not only occur when adapting a product to meet local demands, it can also happen unexpectedly, when misinterpretations in the copying process occur. When these misinterpretations accumulate, outcomes can be far from the original intention.

For example, the interaction between European and Chinese potters in the 16th and 17th centuries copying each other's designs triggered many hybrid motifs on the porcelain. In my previous research (*Sublime Imperfection*, 2015), I focused on the visual representation of motifs in design and the misinterpretations that may occur when one culture copies another's design. For instance, the porcelain charger, [fig. 11.1](#) customized for European usage and made in Jingdezhen in c.1600, has motifs on it that are a hybrid of different cultures and religions. [fig. 11.2](#) In the middle of the plate, we see a creature with five animal heads, a head of a man and a woman



[fig.11.1](#)
Charger,
Jingdezhen Kilns, China,
c. 1600–1620, porcelain,
Peabody Essex Museum
Photo by Jing He

[fig. 11.2](#)
See P.39

enclosed by a shield, and two ribbons on the sides with the Latin motto 'Sapient nihilnovum' (To the wise man nothing is new). [fig.12](#) Many small symbols from Chinese culture decorate the shield, amongst others Chinese coins, and Chinese scrolls etc. These motifs were painted by Dutch artist Willem Claesz Heda (1594–1680) in *Breakfast Still Life* (1638). [fig.13](#) A little like a game of Chinese Whispers, each instance of copying changed the actual design according to who was copying the design. Iranian potters have copied these motifs on different types of vessels as well. However, as we can see in the diagram, [fig.14](#) through this long-term replication, a transformation occurred—the Latin motto gradually became decorative stripes. It is conceivable that the Iranian potters did not know that those symbols held meaning. That is, to them it might be a collection of lines and motifs, and they changed these letters to pure motif, without linguistic meaning. As such, potters from different counties and cultures—Chinese, Dutch, and Iranian—represented the motifs with their own understanding of what they were seeing.

Errors occur in the procedure of copying, which also leads to varied results. Exact copying is difficult—even in mass-production, it is impossible to avoid defective goods. Moreover, errors that occur during copying may result in a new original, and, importantly, the imperfect replica is then copied afterwards. In other words, the practice of copying brings out originality.⁹



[fig.13.1](#)
Breakfast Still Life, Willem Claesz Heda, Hamburger Kunsthalle, c.1838



[fig.13.2](#)
Detail of Breakfast Still Life

[fig.14](#)
See P.36

⁹ For a more detailed description of my findings on this matter I would refer my reader to my earlier research in *Sublime Imperfection*, featured in the *appendix* of this book.

ELEMENTS IN MOTIF OF PORCELAIN CHARGER



MY RESEARCH OF DIFFERENT ORIGINS

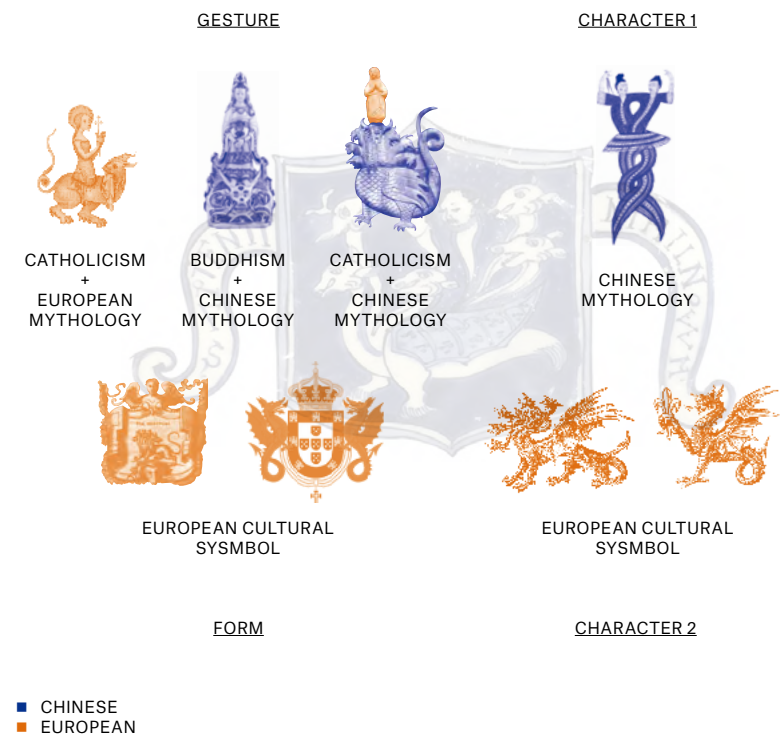

[fig.12.1-2](#)

Top: Detail of the charger, in the middle of the plate, we see a creature with five animal heads, a head of a man and a woman enclosed by a shield, and two ribbons on the sides with the Latin motto 'SAPIENTI NIHIL NOVUM' – To the wise man nothing is new.

Bottom: In my previous research (*Sublime Imperfection*, 2015), I analysed the hybrid cultural and religious origins of the motif. For a more detailed description of my findings refer to the *appendix* of this book.

TRANSFORMATION OF IRANIAN POTTERS COPY

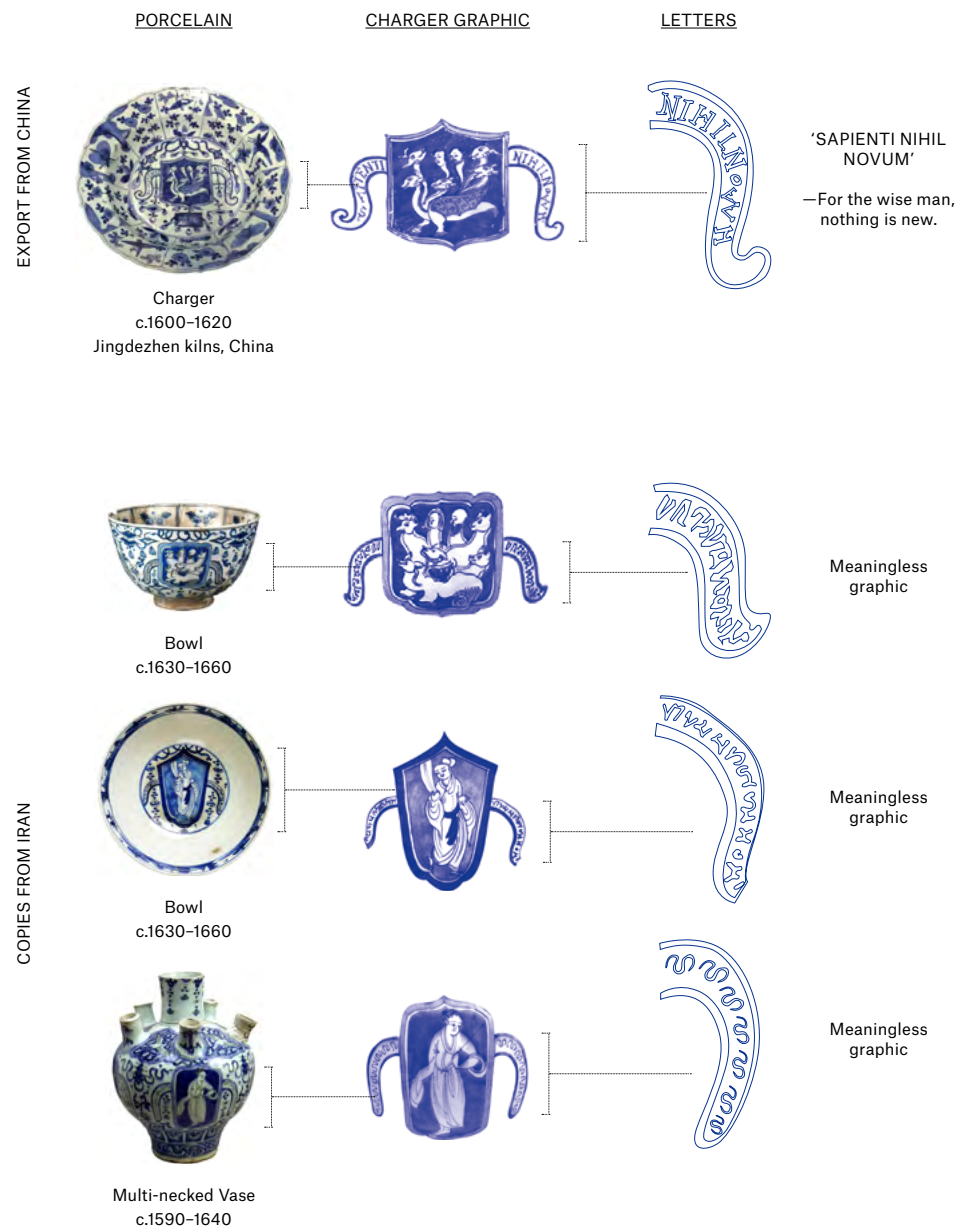

fig.14
Iranian potters have copied this motif on different types of vessels, through this long-term replication, a transformation occurred — the Latin motto gradually became decorative stripes.

4.2

A blurred boundary — the transformation into Delftware and the Tulip Pyramid

The emergence of Delftware is also a good example of the changing roles between the originals and the copies. In the 17th century, the Dutch East India Company (VOC) imported large amounts of porcelain from China, which created an emerging market in Europe. Before Europeans found a way to produce porcelain in the 18th century, the potters in Delft used tin-glazed earthenware. It successfully imitated the appearance of porcelain and it was branded 'Delft porcelain'. In her essay *Imitation and Inspiration* (2014), Suzanne Lambody stated that, 'In order to be able to compare with Chinese porcelain, it was vital that the potters not only created pieces with a similar outward appearance, but that they also faithfully copied both the exotic shapes and the decoration of the successive Chinese stylistic periods.'

The Delft potters had managed to imitate with success. Making a perfect imitation of Chinese porcelain was a way for Dutch potters to show off their skills and the quality of their products. Their financial and commercial success had even spurred other imitative practices in other European countries like the 'English delftware', made by the British. Geared towards the Dutch market, Dutch potters slightly modified these 'exotic' products with motifs or forms derived from their own culture. Dutch businessmen brought the Delftware to China and asked Chinese potters to imitate the Dutch-modified motifs, to achieve a better quality (or to have real porcelain).

The transformation of copying triggers diverse form and function. One of the breakthroughs of Dutch potters, which led to Delftware gaining its unique identity, is the Tulip Pyramid. Although not on the same scale as today, the tulip pyramid is one of those

mass-produced objects of the 17th century. The history of the Tulip Pyramid exemplifies the dynamic process of copying and transformation. During the 17th and 18th century, the shape of the Chinese pagoda had been copied and transformed into the Tulip Pyramid by Dutch potters.

In the booklet *Delft Tulip Vases* (2013) from the Rijksmuseum, Frits Scholten describes the connection between the Tulip Pyramid and the *Porcelain Tower of Paolinxi* (or *Porcelain Tower of Nanjing*) in China as the former being an imitation of the latter: 'The Nanjing pagoda was made of porcelain, the material that the Delft potters had managed to imitate with success'. These pyramids are stored by some of the Dutch museums and when I went to visit the pair on display at the Rijksmuseum in Amsterdam (made in Delft in 1690), I was struck by the differences between the pagoda and the Tulip Pyramid. Indeed, even though the motifs are in a Chinese style, and the pyramid consists of nine storeys of stacked small vases (a number influenced by Chinese pagodas), other decorations were significantly altered. The four lions on the bottom and the four female statues in between, for instance, remind me of the decorations of a Dutch galleon. Even more, the Dutch potters had imitated the form of the porcelain pagoda, but they changed it into a functional object, a vase. [fig. 15](#)

Dutch explorer, Johan Nieuhof (1618–1672), reported on this tower in his writings and his descriptions



[fig. 16](#)
The Porcelain Tower of Paolinxi, illustration in the 1665 edition of Johan Nieuhof's *Het Gezantschap der Neêrlandsche Oost-Indische Compagnie*, [wikipedia.org](#)

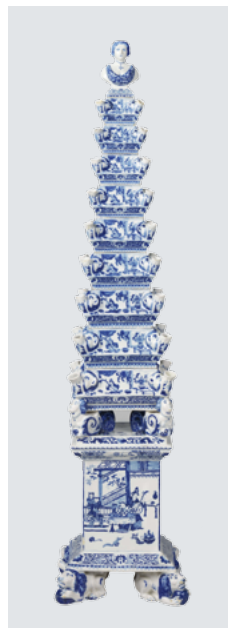

[fig. 15](#)
Tulip Pyramid,
The Metal Pot to Lambertus van Eenhoorn, c. 1692–1700,
H 156cm, Rijksmuseum

of the engravings of the Porcelain Tower inspired the Dutch potters. [fig. 16](#) However, even though Dutch potters in the 17th century were able to imitate the colors and forms of Chinese porcelain with earthenware, there was still a demand for real porcelain. As a result, the VOC sent the tulip pyramids to be copied in China with real porcelain, and therefore, the role of Chinese and Dutch potters changed: the replica made of porcelain, became in fact a copy of itself. [fig. 17](#)

Significantly, the Chinese didn't use the form of the Tulip Pyramid to produce their own products for a local market. They only abided by the commissions from European clients. That is, they were content with copying as closely as they could the Dutch Tulip Pyramid. So, where the Dutch potters were adamant in copying the Nanjing pagoda as a source of inspiration, the Chinese were commissioned to copy the pyramid as closely as they could, with the only difference being the use of actual porcelain. When European-produced porcelain was available on the market in the 18th century, the trading between Europe and China declined, and the trail of copying and transformation goes cold.

As we can see here, the roles of original and copy changed dramatically between Dutch and Chinese potters under the power of economic impulse. The idea of the original gradually blurred by the transformative practice of copying. [fig. 18-20](#)



[fig. 17](#)
Vase with base, Jingdezhen, China, c. 1700, Porcelain,
H 36cm, V&A Museum

According to the description of this vase from V&A museum, the design of this vase was from The Netherlands, and commissioned to the porcelain factories of Jingdezhen by European clients. [vam.ac.uk](#)

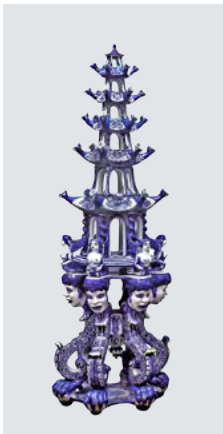

[fig. 18](#)
Flower Pagoda,
De Metal Pot under Lambertus van Eenhoorn,
Delft, c. 1700, H 150cm,
Rijksmuseum



[fig. 19](#)
Porcelain pagoda,
China, late 18th century,
H 150cm

THE BRIEF HISTORY OF THE TULIP PYRAMID AND THE PORCELAIN PAGODA OF PAOLINXI

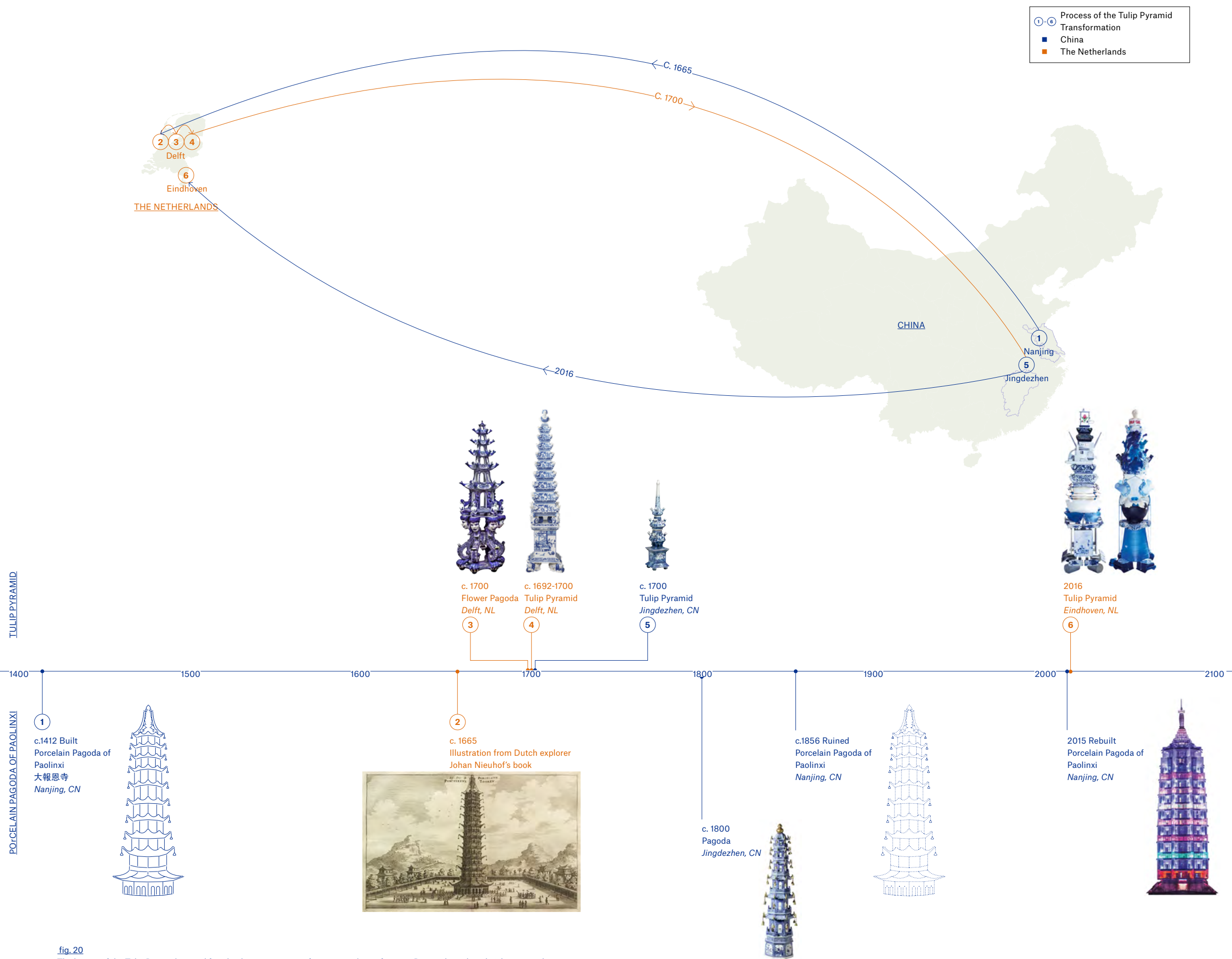

fig. 20

The history of the Tulip Pyramid exemplifies the dynamic process of copying and transforming. During the 17th and 18th century, the shape of the Chinese pagoda had been copied and transformed into the Tulip Pyramid by Dutch potters. VOC sent the tulip pyramids to be copied in China with real porcelain, and therefore, the role of Chinese and Dutch potters changed: the replica made of porcelain, became a copy of itself.



Chapter 5

Hybrid: a design method inspired by the reality of copying in China

Global culture today is a giant anamnesis, an enormous mixture whose principles of selection are very difficult to identify.

—Nicolas Bourriaud, *Postproduction*, 2007

After analyzing the complicated background of the phenomenon of copying in China, and of copying as a power of transformation in history, I attempt to assess my own identity with regards to the China of the 21st century. The Communist Party of China is still in charge of the social and economic transition into a capitalist system in modern China. The party intended to invent a hybrid system that combines socialism and capitalism. They called this hybrid system 'Socialism with Chinese characteristics'. Their aim is to keep the notion of common ownership and infuse it with a market economy principle. The fast development in China is a double-edged sword: it brings wealth, but a crisis of culture and ideology as well. I realized that I grew up in a cultural grey area of socialism and capitalism, collectivism and individualism. I feel there is a gap between traditional and modern education in the history of Chinese education. The Chinese modern education system followed a Japanese and American system in the late 19th century and later reformed into a Soviet model after 1949. Later the system was rebuilt again after the Cultural Revolution in the 1960's. As a result, I was not trained in a traditional way. Especially when I studied art in high school, the general education was more close to the Soviet model. I studied realistic drawing and painting, instead of Chinese traditional calligraphy and ink painting, which is the art academy's criterion for choosing students. It is an imperfect system for a country, but it is a fact in China. Because I find it hard to define what China is, I wonder if I can bring out a design method that reflects this grey area I grew up in?

—

5.1

Communism of form and personality

In theory, communism and socialism are economic and political structures that are based on common ownership of the means of production. They aim at promoting equality and eliminating social classes. 'Communism of form' is a term coined in the book *Postproduction* (2001) by Nicolas Bourriaud. He encourages artists to use the products around them, beyond appropriation, moving towards a culture with a free use of form, without ownership. Bourriaud, 'In the face of the economic abstraction that makes daily life unreal, or an absolute weapon of techno-market power, artists reactivate forms by inhabiting them, pirating private property and copyrights, brands and products, museum-bound forms and signatures. If the downloading of forms represents important concerns today, it is because these forms urge us to consider global culture as a toolbox, an open narrative space rather than a univocal narrative and a product line.'

Although there are different discourses between art and design nowadays, his opinion gives us a practical direction for copyrights and ownership issues in design. Laws protect intellectual property, but as a designer, you quickly realize that IP-law cannot protect every aspect of design. Others will use ideas, and ideas always come from the ideas of others. This might even be considered inspiration through influence, and reference. Creations are generated through transformation, in a process of copying and being copied. As we share, download and appropriate the products we find, Nicolas Bourriaud suggests a more active, collectivistic way of facing copyrights and ownership,

Collectivism has a much longer history than communism, but communism uses it as an important ranging tool for possible political and economic

positions. I have been educated in a collectivist atmosphere, when I was a child in school, and I learned that one's personality is not as important as the image or honour of the group. A common negative comment to people was, 'He (or she) has a strong personality'. In the collectivistic sense, an individual is defined by the group, and a strong personality infringes upon that ideology. But with the booming market in the last 10 years, I observed that 'personality' gradually became a positive word in Chinese society.

One possible way to show my identity in my works is by building up a design method that reflects my background, experience, observation, conflicts and changes. I attempt to explore the hybrid elements in design, which contain the possibility of 'communism of form', the collective working procedure that balances different personalities.

5.2

The conflicts and problems

We have always been seamless about stealing great ideas.

—Steve Jobs, *documentary Triumph of the Nerds of PBS*, 1996

I'm going to destroy android because it's a stolen product. I'm willing to go thermal nuclear war on this. Ok, so in other words, great artists steal, but not from me.

—Steve Jobs, recorded in *Walter Isaacson's biography Steve Jobs*, 2010

The current political and economic systems in China contain many conflicts. The design method I aim for will confront these problems. Firstly, it is about ownership and authorship. In post-modern art and contemporary design, artists and designers have a wider freedom to appropriate, copy and edit existing commodities. Even though they have tried to challenge copyrights, their sense of ownership seemed to contradict their practice or ideas. Bourriaud took the art dealing in the 80s

as an example, 'The art of the eighties criticized notions of authorship and signature, without however abolishing them. If buying is an art, the signature of the artist-broker who carried out the transactions retained all its value, indeed guaranteed a successful and profitable exchange.'

Artists who appropriate others' works may not allow others to do the same thing with his or her own works. In other words, appropriation does not mean free copyright. For instance, Jeff Koons has been accused of copyright infringement several times; he appropriated photography, pop-culture icons, commodities and advertisements. In 2011, Jeff Koons remarkably sued San Francisco gallery, Park Life, for selling bookends shaped like his sculpture *Balloon Dog*. Park Life's lawyer argued that 'no one owns the idea of making a balloon dog, and the shape created by twisting a balloon into a dog-like form is part of the public domain.'¹⁰ Artist Paul McCarthy appropriated Jeff Koons' Balloon Dog in 2013. Although it was not the first time he had appropriated Koons, it was different from the case of Park life. McCarthy has never been in any legal trouble with Koons. The issue at hand is that while Koons freely appropriates mass-produced product designs, but once appropriated by him, his art becomes a unique creation, and therefore susceptible to IP disagreements. [fig. 21.1-4](#)

Whether copyright laws should protect the ideas of appropriations and copying, is a controversial issue. In 2015, there was a big exhibition in Shanghai, China called *Copyleft—Appropriation Art*, which aimed at discussing and reflecting on the phenomenon of copying in China. Art critic Libin Liu noted in his review in the *Oriental Morning*



[fig.21.4](#)
Balloon Dog, Paul McCarthy, 2013, Artist Paul McCarthy appropriated Jeff Koons' Balloon Dog in 2013, and although it was not the first time he appropriate Koons, different from the case of Park life, McCarthy has never been in any legal trouble with Koons, [supremefiction.com](#).



[fig. 21.1](#)
In 2011, Jeff Koons sued a San Francisco gallery called Park Life for selling bookends that were shaped like his sculpture balloon dog.
[foudroyante.com](#)



[fig.21.2](#)
Owner Jamie Alexander (right) of Park Life store and gallery, next to the balloon dog bookend at his store.
Photo: Liz Hafalia,
The Chronicle

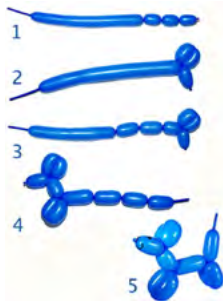

[fig.21.3](#)
Balloon dog modeling, Lawyer for Park Life argued that the balloon dog should be part of the public domain, because any clown can make it, no one owns the idea of making a balloon dog and creating the dog-like shape.

¹⁰ Park Life gallery defies Jeff Koons' legal bark, San Fransisco Gate [sfgate.com](#)

Post, that the curator used the title *Copyleft*, which suggests an indication to affirm the right to freely distribute copies and modified versions of a work. However, seeing as all the works in the exhibition had copyrights, it seems the title was just an eye catcher.

Some artists used the profits they gained from their art as a tool to discuss copying, as did Francis Alÿs with his work *The Liar/The Copy of the Liar* (1993–1994). He painted some small oil paintings that he copied from commercial advertisements on the street, and asked commercial advertising painters to copy his paintings on a large scale. He sold those works in the art gallery as unlimited editions, and paid the painter half of the profits from the sale. These works present the artist's awareness that the price and the role of a copy changes in a different context and discourse. I consider sharing the profits an important part in these works. Although Alÿs says that the project was an attempt to disturb the art market by producing an unlimited number of the painting. The ability for the painting to earn a profit indicates that Alÿs' reputation, and not the artwork alone, influenced the increased profit for the painter's labor. [fig. 22](#)



[fig. 22](#)
Studio view of *The Liar, the copy of the Liar*, Francis Alÿs, Mexico City, 1994
[arttattler.com](#)

Inspired by these examples, we see that copying and appropriation make sense in theory, and that they may even appeal ideologically, but also have the difficulty to run in the 'practical' world. Every time copying, imitation, and appropriation is an issue in art or design, it seems to raise conflict (Koons and Park Life) or contradiction (copyrighted art work at Copyleft). I don't want my design to claim a new solution, but rather I want to create awareness of the possibility and conflict in the topic of ownership and authorship. So, when I execute my design, I need to be aware of the possibilities and limitations in the practical world, and I want my design to reflect those limitations and possibilities.



Chapter 6

Design method and practice

Back to the initial question in the first chapter—What is my identity? What does the word ‘Chinese’ mean to my work and me? My project followed these questions, researched what is happening in current Chinese society and looked at my transition from China to the Netherlands. Studying the phenomenon of copying in China, I found blurry boundaries between original and copy. In my opinion, a ‘specific’ or a ready-made Chinese identity probably does not exist. However, I want to approach a design method that can help me to concretize the questions of identity into objects that can develop into products. This design method can also be seen as a precedent for other designers dealing with identity issues.

In my method, the design starts with research. I prefer to find the qualities that have been ignored in the contradiction and problems in contemporary society. During the research phase, the questions and problems that arise can be relegated to the historical, economical and political context. In my case, I studied the contradiction between copying and identity in a design and cultural context, with a specific focus on the history of Tulip Pyramids. Research can help designers to find the right context and foothold, but it should not be the only manual of execution. Theory can give a direction to making. However, it cannot predict the results. I wish to reach an unexpected result about identity that cannot be explained through mere writing. The results will be the identity of the present, not reflective of traditions from centuries ago, nor the fictional identity we wish to have in the dreamy future, but the experience gained from the execution of the qualities of copying.

In my project, I decided to ‘continue’ the transformation of a Tulip Pyramid. The world has changed in the past 400 years and both Delftware and blue-and-white ceramics have become cultural symbols of sorts—even cliché or kitsch—to both countries. Delftware is no longer the earthenware that imitated porcelain. Only a factory like Royal Tichelaar Makkum in the Netherlands still makes a small number of luxury objects using traditional methods. Delft Blue can be found in souvenir shops in the form of little clogs or windmills. One underlying aspect has not changed though: trade between Dutch and Chinese is still as strong as it was 400 years ago, and Chinese factories are still producing for Europe. I tried to imagine how contemporary Chinese manufacturers would reshape a tulip pyramid. To find out the possible outcomes, or even to make another breakthrough in these processes, I started by learning the current cultural and economic situation of China before continuing the transformation.

In the previous chapters, I analyzed how design is part of the industrial procedure of mass-production in China, with copying being an integral part of the production process. As I have stipulated, copying is regarded as unoriginal, or at times, even considered fraudulent. However, my education in the Netherlands has given me a different perspective on copying in design. As opposed to a marketed brand or company, many Dutch designers are famous for expressing strong personalities in their works. I am also encouraged to show my personality in my works. Besides merely designing for mass-production, I can make use of my personal experience to ask questions about this process. I think the identity of Chinese products

is different from my own identity in this project, because I am not currently working in industry, but as an individual. This project should be a long-term process; this research as part of my graduation, is only a starting point. I expect this project to keep growing and evolving as it hits mass-production in the future.

—

6.1

Combination of collective work and various personalities

Inspired by the current political system and the cultural background of China—which combines common and private ownership, collectivism and individualism, as well as my own experience as a design student in the Netherlands, I decided to copy a pair of Tulip Pyramids using the following two complementary ideas: one pyramid is about collective work and ownership, the other is about my identity as a designer. For the one about collective work and ownership, I invited five Chinese designers from my generation to copy one of the large Tulip Pyramids together with me. They are from different design professions, including graphic design, industrial design, programming and traditional ceramics.

I had to tread carefully with regards to intellectual property rights in this project. The pair of vases we replicated fall under the Public Domain Dedication, which means one can copy, modify and distribute the work, even for commercial purposes, all without asking permission. I had to make this clear. The physical pyramids are the property of the Rijksmuseum, but we are allowed to freely copy

the shape and use the imagery. Once we copy this vase and put it in a new context, it generates new copyrights, authorships and ownerships. I decided to share the ownership of the final product between all six of us. In other words, we are the authors and the owners of the copied Tulip Pyramid. I would like to make the ownership and authorship of this pyramid ambiguous, to discuss more IP issues in collective authorship and copying.

The other tulip pyramid is about my own personality with relation to my education in a Dutch design context. When I see the tulip pyramid, I think about the Dutch potters who tried to figure out how to copy Chinese porcelain in the 17th century, conducting many experiments to search for the closest material to imitate it. In the end, the transformation of copying led these potters to find out their own methods and aesthetics. In my case, I asked: how does my Dutch design education shape my methods and aesthetics? I chose several renowned Dutch designers and started to copy their style and iconic works, as a new starting point of transformation.

6.2

The process of collaboration and creation

My peers, the ones who have helped this design come to fruition, are Shanghai-based designer/artist Rongkai He and Cheng Guo, designer/ceramist Dangdang Xing who works in Jingdezhen, Berlin-based industrial designer Dawei Yang, and London-based graphic designer/artist Weiyi Li. The reason I chose these designers is by researching their former works I found potential links with this project. I contacted them and we communicated digitally, mostly using a mobile chat application.

First I shared the information and my research in a common folder with them, and gave the commission to each person to copy two storeys of the Tulip Pyramid. Each designer was free to use his or her own method of copying while keeping to the original size and the typical blue-and-white color. I had my own two storeys to make, and at the same time, I was the organizer, coordinator and sometimes their assistant. This pyramid will be a combination of our personalities and visions of history.

SUMMARY OF THE RESULT OF COLLABORATION

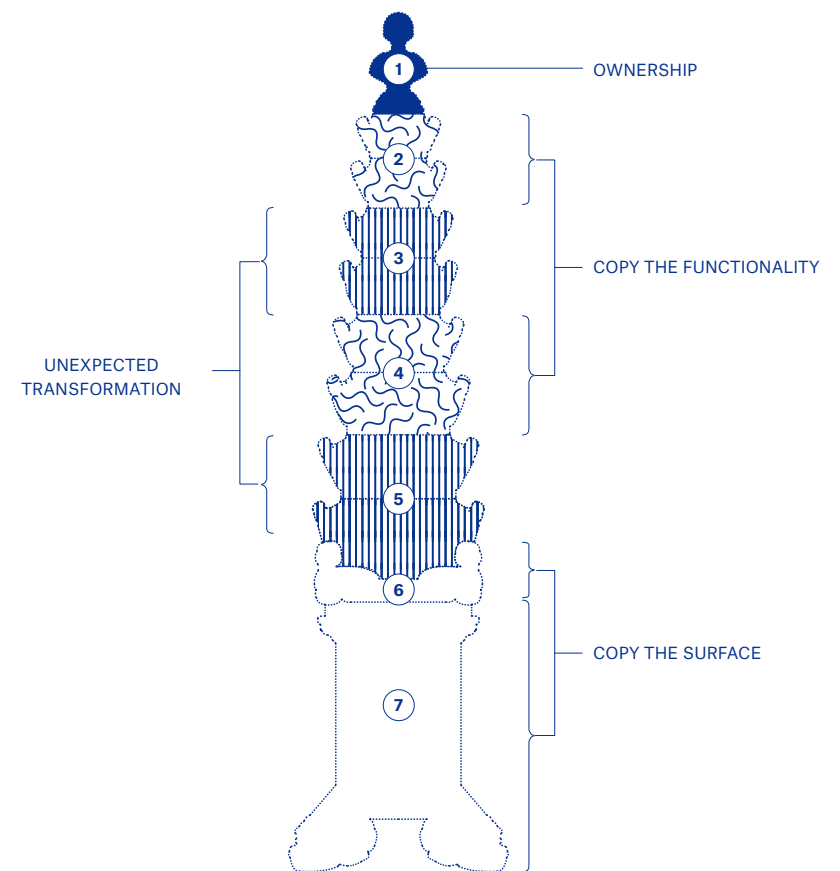

6.2.1 Unexpected transformation

The first person I wanted to collaborate with was someone from Jingdezhen, which is the old Chinese city that has made porcelain for European customers since the 16th century. I specifically wanted to have part of the pyramid made in this historic city. There are thousands of craftsmen and small factories producing porcelain in this city. I am not the only one who is interested in the topic of copying and craftsmanship there. Some Chinese artists made similar projects before, such as Ni Haifeng's project *Of the Departure and the Arrival* (2005) [fig. 23](#) and Zhenhan Hao's project *Imitation, imitation* (2014). [fig. 24](#) After studying their projects, I was sure that I was more interested to start a dialogue with a specific person there, instead of searching for an anonymously crafted object. However, it was difficult to find someone who really understood my aim with this project. I had been rejected a few times, and without physically being there it was nearly impossible to communicate with a craftsman because they only craft things following the orders of their mentors or the owners of the factories. One of the ceramic workshop owners told me the craftsmen in her studio only know how to copy the samples and not create things by themselves. During conversations with different people there, I noticed that the precision and quality of the copying strongly related to the quantity, size, time and money of the client.



[fig. 23](#)
Of the Departure and the Arrival, 2005, Haifeng Ni, haifeng.home.xs4all.nl



[fig. 24](#)
Still image of *Imitation, imitation* (film), 30 minutes, 2014, Zhenhan Hao, hanzhenhan.com

Finally I found **Dangdang Xing** who graduated from the Jingdezhen Ceramic Institute. He has been educated as a designer of traditional ceramics. I suggested to him that he copy one storey of the pyramid as close to the original as possible, and the other storey using his own style and idea. I sent him the photos I took from the Rijksmuseum as examples, plus some sketches with some dimensions. Later he discovered a big mistake in the sketch that I and the other designers hadn't noticed — we all misunderstood the basic form of each storey. [fig. 25.1-3](#) We therefore needed to discuss whether or not to spend more time and budget to create the correct form, and wondered if the corrections would be noticed. It reminded me of the misunderstandings I had described in my previous research (see appendix). It seems that we unconsciously transformed the copy in the process of copying. The form changed because of the carelessness of the copying process in the beginning, but the mistakes have been kept because of time and budget limitations. [fig. 26.1-3](#)

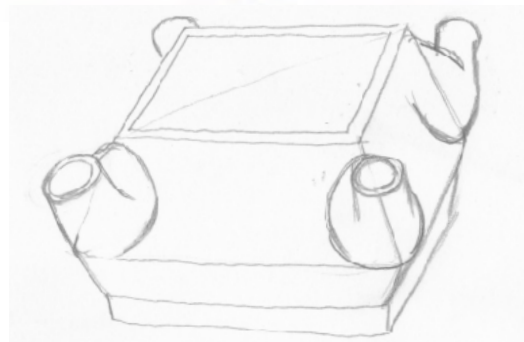
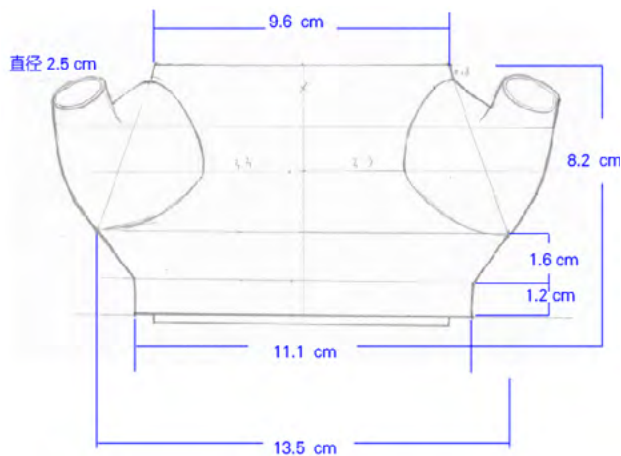

[fig.25.1](#)
The sketch I sent to Dangdang Xing



Previous works of Dangdang Xing

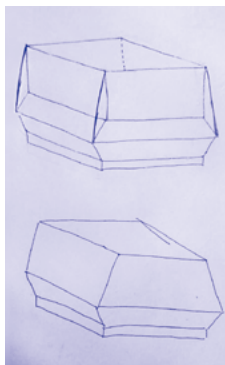

[fig.25.2](#)
Dangdang Xing sent me this image to show the incorrect part of my sketch.

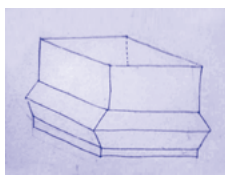

[fig.25.3](#)
The image shows the correct form of each storey of the pyramid.



[fig.26.1](#)



[fig.26.2](#)



[fig.26.3](#)

[fig.26.1-3](#)
Due to budget and time limitations, we agreed to copy the 'incorrect' form.

Cheng Guo is another one of the designers I wanted to collaborate with. He overturned the relationship between the human body and tools in his former works *Mouth Factory* (2012). [fig.27](#) I was curious how he would deal with the relationship between the original and the copy in the project. The transformation caused by the cultural misunderstandings in the history of Delftware caught his attention. Initially he was having trouble finding a design based on copying, until he received the two porcelain storeys made by Xingxing Dang. He was inspired by Google DeepDream, an online software program that connects to artificial neural networks 'trained' to understand the images people upload. This software was initially designed to detect faces and other patterns in images. However, it always 'recognized' many irrelevant things from the given images and generated surreal images. [fig. 25.4, 28](#) Cheng Guo decided to let Google DeepDream 'look' at the part of the pyramid made by Dangdang Xing and be inspired by the result to add a new storey to the pyramid. 'When Dutch potters copied the form of the pagoda, they didn't understand the meaning of it. I am using Google DeepDream generator to copy the tulip pyramid, to represent the misunderstanding,' Cheng Guo said. Industrial designer Dawei Yang helped him analyze the data of the object and transfer all the images of the pyramid generated by Google DeepDream into a 3D model, producing a 3D print in the end.

Cheng Guo's work builds on the mistakes from Dangdang Xing's work and adds the misunderstandings produced by Google DeepDream as well as all the other small errors that come from the different technologies. [fig. 29, 30, 30.1, 31](#)



[fig.25.4](#)
The details of Tulip Pyramids in *Rijksmuseum*,
Photo by Jing He



[fig.28](#)
The result generated by DeepDream. On closer inspection, DeepDream generated many forms resembling the eyes of animals or fruits, because DeepDream 'understood' the form and colour in the original photo as such things.



[fig.27](#)
Still image of *Mouth Factory*,
Cheng Guo, 2012
Source: chengguo.co.uk



[fig.29](#)
The preparation of the photo 3D scanning of the storey made by DangdangXing. Later Cheng Guo took photos around the object, and put all the photos into the Google DeepDream generator to have a set of new photos. In the end the combined photos generated from Google DeepDream in the 3D programme resulted in a new object.

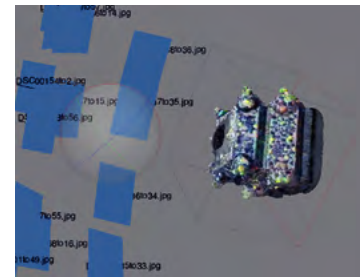

[fig.30-30.1](#)
Combining the photos generated from Google DeepDream into a 3D model.



[fig.31](#)
The 3D printed result.

6.2.2 Copy the functionality

Dawei Yang did not only help Cheng Guo, he had his own two storeys to make. As for his part he said, 'I am interested in the data of an object, and searching for the different methods to export the data.' In his previous work, he built a digital generator which transfers the data of Chinese traditional paintings into 3D-printed ceramic objects. Because of the Public Domain Dedication Copyrights of the Tulip Pyramids in the Rijksmuseum, I can go to the museum and scan a photo of it without explicit permission. I collected the data of the pyramids for him in the museum in Amsterdam. The whole process was much easier than I expected, so in theory everyone can share the 3D data of one object with others by using a camera and software.

With the 3D model of the Tulip Pyramid, Dawei Yang analysed the principle behind the forms. Later, by studying the evolution of the Tulip Pyramid, he noticed that Dutch potters gave a new function to the upturned eaves when they copied the form of the pagoda—by turning them into an opening of a vase. Dutch potters got more freedom to look at the form of the pagoda without having the Chinese cultural and aesthetic knowledge, and limitations. 'Dutch potters gave functions to the upturned eaves of the pagoda. So my design is about 'the flowing eaves.' So he wanted to copy this principle where every connecting point in the structure has the potential to be given a new function. [fig. 32-34](#)



[fig.321-3](#)

Left: The upturned eaves in traditional Chinese architecture.

Middle: Detail of an illustration of the Porcelain Tower of Paolinxi where bells hanging on the upturned eaves of the pagoda.

Right: From these three images, we can see the transformation of the upturned eaves in the pagoda to serve as a vase.



Previous works of Dawei Yang

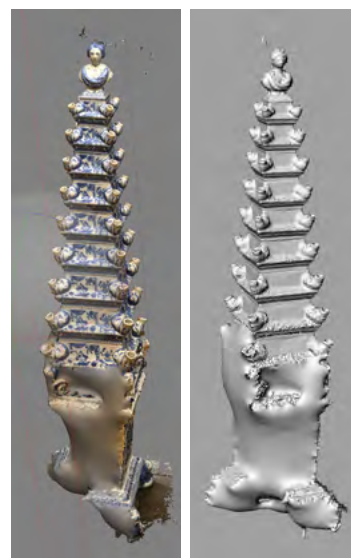

[fig.33](#)

The 3D model generated from the photos I took in the museum.

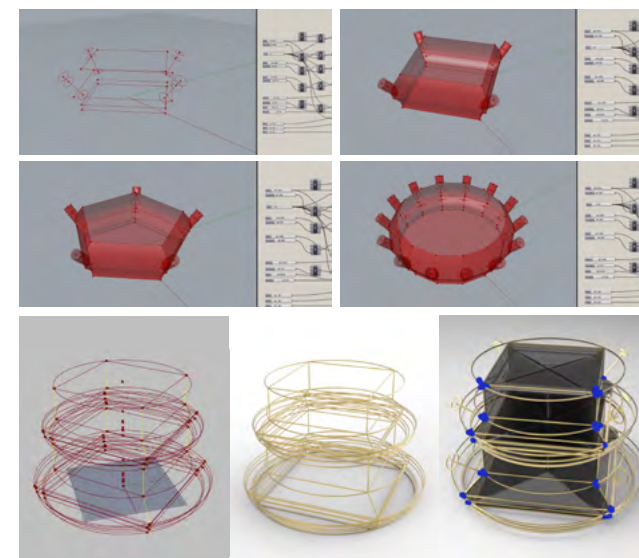

[fig.34.1](#)

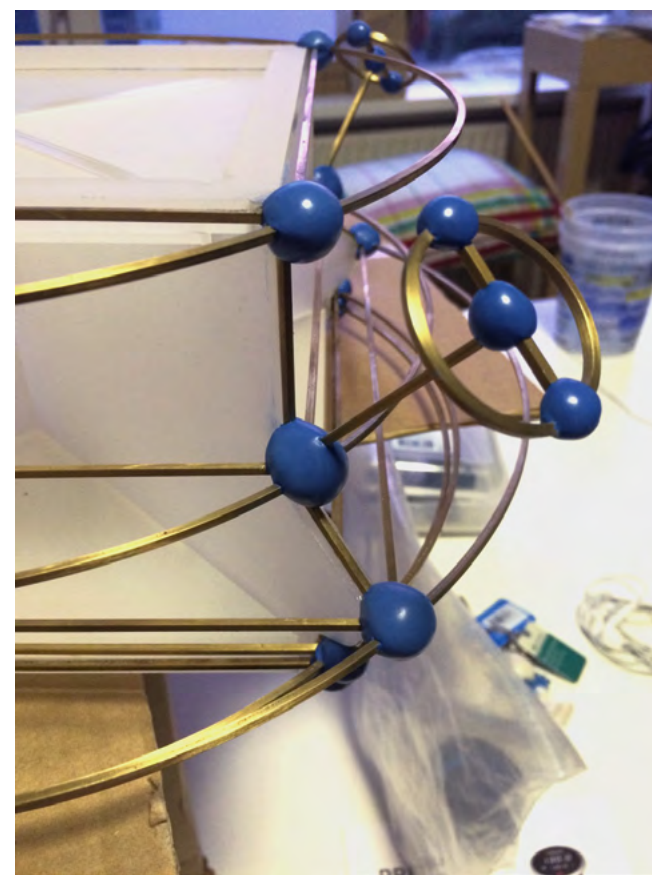

[fig.34.1-2](#)

Dawei Yang analysed the structure of the Tulip Pyramid.

Artist/designer **Weiyi Li** also focused on the function of the Tulip Pyramid, but by analysing its function in a living space. The centrepiece is an important decorative element in the room. A vase taller than 150 cm is bound to attract people's attention in a space. People would like to put it in a prime position, such as in the space that hosted the meeting between President Obama and Dutch Prime Minister Mark Rutte in 2014. [fig.35](#)

Weiyi Li views the centrepiece in contemporary life as a place for electronic devices, such as the WiFi router, electricity socket and battery. She decided to copy the function of the Tulip Pyramid as a location for ready-made electronic devices. 'In our living space, many things are set around sockets, therefore we arrange the objects depending on where the sockets are. Electricity and the Internet signal have become the geographical centre of our lives.' [fig.36](#)



Previous works of Weiyi Li
H&M&H&M, 2014
 Catalog of H&M&H&M
 project, 21 × 28.5 cm, 16 pp.
 Edition of 50
 US \$10/RMB ¥60



[fig.36.1](#)
 AC/DC Snakes, 1995-2010, Philippe Parreno



[fig.35](#)
 Meeting of President Obama and Dutch Prime Minister Mark Rutte in 2014



[fig.36.2](#)
 A sketch of Weiyi's design.

6.2.3 Copy the surface

In the first chapter, I mentioned that European styles of architecture are popular in China. When I discussed this phenomenon with designer **Rongkai He**, he told me his parents are big fans of this kind of hybrid Chinese—European style, and showed me some photos of the interior design of their house. [fig.37](#) I was fascinated by all the details in the furniture in the house. Rongkai He asked: 'Are the Chinese-style decorative patterns on the Dutch Tulip Pyramid from the 17th century similar to European style furniture in contemporary China? What really drives people to imitate exotic cultures? Is it something to be ashamed of? And what is the value of it?' With these questions, he decided to use a very direct way of copying the decoration of the furniture in his parents' house. He put silicone on a cabinet, a chair and a lamp, and sent these moulds to me. [fig. 38](#) Then I continued casting the decorative elements on the surface of the objects into new silicone pieces.



Previous works of Rongkai He, *Unlimited Limited*, 2015
Unlimited Limited is a venture communist corporation, or an austere capitalist commune. It is an experiment on the form of the business organisation. Making revenue from advertisement, it then distribute its humble wealth and power equally to its shareholders, which is open for anyone to sign up, free of charge.
unlimitedltd.co

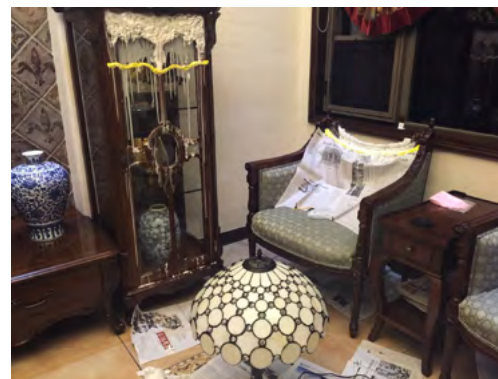

[fig.38.1](#)



[fig.38.2](#)



[fig.37.1-2](#)



[fig.37.1-3](#)
The living room of Rongkai He's parents' house.



[fig.38.1-3](#)
Rongkai He put silicone on the surface of some furniture to copy the decoration.

The last part of the Tulip Pyramid was made by **me** based on research of fake iPhones in the Chinese local market. I have been fascinated with all kinds of fake iPhones for years and with the variety of them, from the exact copy to the product that only produces a similar Apple logo on the back. I analysed various copies from different approaches; from the operating system to the appearance. [fig. 39](#) Noticeably, a big group of fake iPhones borrowed only a few elements from the original, but it is enough to remind people of the original. I found this to be an interesting design strategy in my contribution to our pyramid project. I experimented with some models, separating the elements from the iPhone 5S and iPad Air that I was using to communicate with other designers: the material, size, weight, key symbols, and the way the finger swipes during usage. I decided to copy the same elements from Apple products in a very shallow and superficial way like most of the cheap fakes in the market are. Many small factories want to copy high technology products but have limited facilities and capabilities. My own situation could compare to this in terms of technical limitations. What could I copy from the surface of an iPhone in the context of the Tulip Pyramid? In the end I chose to use elements like size (iPhone 5s, iPad air), material (aluminium, earthenware), and my fingerprints on the screen that result from swiping it—an alternative record of communication during this collaboration. [fig. 40](#) In the original Tulip Pyramid, the motif on the base of the vase depicts an imaginary scene of daily life in ancient China. Correspondingly I saw the fingerprints left on the iPad and iPhone as a sort of contemporary daily life scene. [fig. 41-43](#)



[fig. 39](#)
From top to bottom: the whole spectrum of fake iPhones from exact copies to those that only feature an Apple-style logo on the back. Images sourced online.



[fig.41-42](#)
Top: fingerprints left on the touch screen after using the devices for a few hours.
Bottom: Later, baby powder was used to capture the fingerprints which were then scanned and adjusted into patterns.



[fig.40](#)
Using wood models I copied different elements from an iPhone: the size, form, weight, forms of the buttons and patterns of usage.



[fig.43.1](#)
Detail of the base of the original vase.



[fig.43.2](#)
The aluminium structure of the base.



[fig.43.3](#)
The paper model with fingerprints motifs of the base.

6.2.4 The ownership/authorship

On the top of the original Tulip Pyramid is the statue of Queen Mary II (1662–1695), because the initial design was made for her. I viewed this as the symbol of ownership of the vase, so I invited **Rongkai He** to create a similar symbol emphasising common ownership on the top. 'I view this Tulip Pyramid as public space, participants can share their voices here. I didn't see the copying and imitation, but the flowing of cultures and ideas in this vase.' He designed a performance for us in a Chinese chatting application, the main tool we used to discuss the project for over three months. The text box was stacked like the structure of the Tulip Pyramid, so we texted with the certain order of emojis designed by Rokngkai He that imitated the appearance of the vase. He recorded the performance and turned it into an animation afterwards. Our collaboration is highly dependent on the Internet and some of us have never met in real life, but we know each other's profile pictures from the chatting app. [fig.44](#) In the other pyramid that I made, I scanned myself and 3D printed my portrait to put on the top of the pyramid. [fig.45](#)



[fig.44.1](#)



[fig.44.2](#)



[fig.44.3](#)

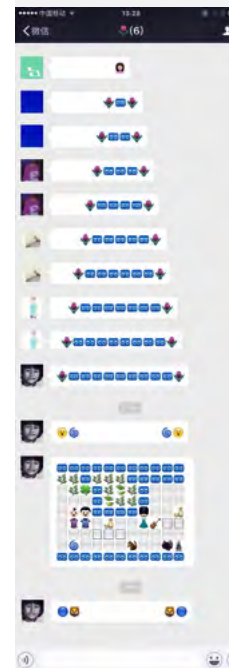

[fig.44.1](#)
Tulip emoji used it as the name of chatting group of the project.

[fig.44.2](#)
Still of the animation made by Rongkai He, it shows our profile pictures turning around the tulip emoji.

[fig.44.3](#)
The emoji version of the Tulip Pyramid.



[fig.45.1](#)



[fig.45.1](#)



[fig.45.2](#)



[fig.45.1](#)
The statue of Mary Stuart on the top of the original Tulip Pyramid.

[fig.45.2-45.3](#)
3D scanning and printing of my portrait.

The original Tulip Pyramid has four sides, but because of the statue of Queen Mary, it is easier to see the pyramid with front and back sides. Therefore I printed my portrait with two sides, to blur the front and back.

6.2.5 Using others' language as material

The collective working process was a unique experience, mostly because of the unexpectedness of the results. Even though each constructed part was not created in isolation, the process was more dynamic than I expected. Sure I designed the structure and rules, but I didn't know what the whole pyramid would look like until I received all the packages from the other five designers.

The original Tulip Pyramids traditionally came as a pair. I wanted to make another pyramid and provide a design method based on my own personality. The collaboration was a way of putting different languages together, and using the languages of others as a design method for an individual. My previous work called *Too Far to Care* (2015) was the first experience wherein I made use of another artist's language as a material. I studied British artist Grayson Perry's works, in which he mixed craft, personal experience and his reflection on world issues in his works. Using his language, I made a video about people's distant attitude towards major issues such as the Ebola epidemic in Africa. [fig. 46-47](#) From this practice I found a method of 'digesting' different elements in one work.



[fig.46_47](#)
Top: Grayson Perry at a fair in Germany
thevintagent.blogspot.co.nz

Bottom: Still image from *Too Far To Care*, 2015, Jing He

Echoing the collaboration of other pyramids, I decided to find five renowned Dutch designers and study their works. The challenge was that I didn't want to make another pyramid with clear boundaries of layers and merely display which designers' language I was using because that would create a distinctly predictable result. Instead, I wanted to find a balance between playful creation and serious research. The research aims not only to



ELEMENTS FROM
MY WORKS
CERAMIC
CUPS
MULTI-NECKS
LEGS

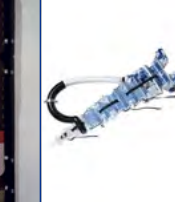
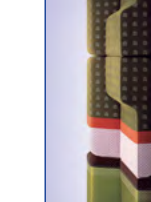

ELEMENTS FROM HELLA JONGERIUS

ELEMENTS FROM TULIP PYRAMID

	4 CORNERS	4 ENTRANCES					
FLEXIBLE SKIN	4 CORNERS FLEXIBLE SKIN	4 ENTRANCES FLEXIBLE SKIN	CERAMIC CUPS MULTI-NECKS LEGS	CERAMIC CUPS MULTI-NECKS LEGS	CERAMIC CUPS MULTI-NECKS LEGS	CERAMIC CUPS MULTI-NECKS LEGS	CERAMIC CUPS MULTI-NECKS LEGS
READYMADE	4 CORNERS READYMADE	4 ENTRANCES READYMADE	CERAMIC CUPS MULTI-NECKS LEGS	CERAMIC CUPS MULTI-NECKS LEGS	CERAMIC CUPS MULTI-NECKS LEGS	CERAMIC CUPS MULTI-NECKS LEGS	CERAMIC CUPS MULTI-NECKS LEGS
DRILLING	4 CORNERS DRILLING	4 ENTRANCES DRILLING	CERAMIC CUPS MULTI-NECKS LEGS	CERAMIC CUPS MULTI-NECKS LEGS	CERAMIC CUPS MULTI-NECKS LEGS	CERAMIC CUPS MULTI-NECKS LEGS	CERAMIC CUPS MULTI-NECKS LEGS
TEXTILE	4 CORNERS TEXTILE	4 ENTRANCES TEXTILE	CERAMIC CUPS MULTI-NECKS LEGS	CERAMIC CUPS MULTI-NECKS LEGS	CERAMIC CUPS MULTI-NECKS LEGS	CERAMIC CUPS MULTI-NECKS LEGS	CERAMIC CUPS MULTI-NECKS LEGS
PLASTIC TIE/TAPE	4 CORNERS PLASTIC TIE/TAPE	4 ENTRANCES PLASTIC TIE/TAPE	CERAMIC CUPS MULTI-NECKS LEGS	CERAMIC CUPS MULTI-NECKS LEGS	CERAMIC CUPS MULTI-NECKS LEGS	CERAMIC CUPS MULTI-NECKS LEGS	CERAMIC CUPS MULTI-NECKS LEGS

[fig.48](#)
An example of the tabulation I used to combine elements of Hella Jongerius' works with elements from the Tulip Pyramid and my previous works.

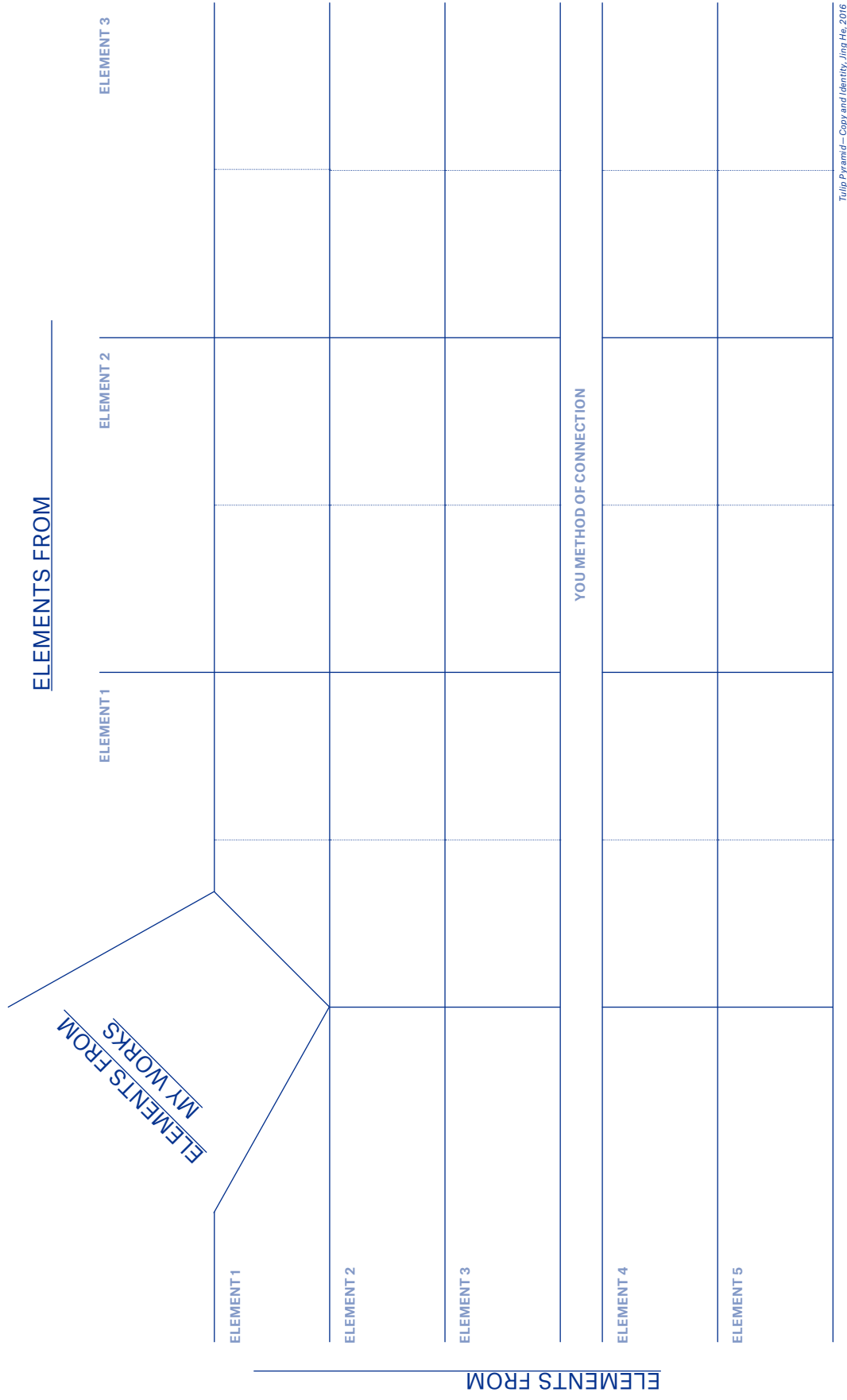

Tulip Pyramid—Copy and Identity, Jing He, 2016

*Start your copying work today!

support an aesthetic vision but also to interact with the material and methods used by these designers. Besides looking at their works, I read or watched interviews with the five designers as well. When I considered their works as material for a pyramid, I tried to imagine that I was the 17th century Dutch potter seeing the image of a Chinese porcelain pagoda for the first time. I was free to understand what I saw without any rules or known interpretations.

I chose the five Dutch designers: Hella Jongerius, Marcel Wanders, Maarten Baas, Bertjan Pot and Joep van Lieshout. I made a tabulation [fig. 48](#) for each designer and generated different drawings from his or her designs. These tabulations helped me to mix key elements from each of the Dutch designers with my own work completed while studying at Design Academy Eindhoven. Each crossed-out box in the table is a remix of different areas from which I drew a preliminary sketch. Later I chose some of the drawings as the new starting point. For me it was like a digestive process of these designers' languages concentrated into a Tulip Pyramid; it was a visual manifestation of my design method. When I show the work, I only show the combination of the designer's initials—H.J.M.B.M.W.J.V.L.B.P.

fig.48
See P. 71



=

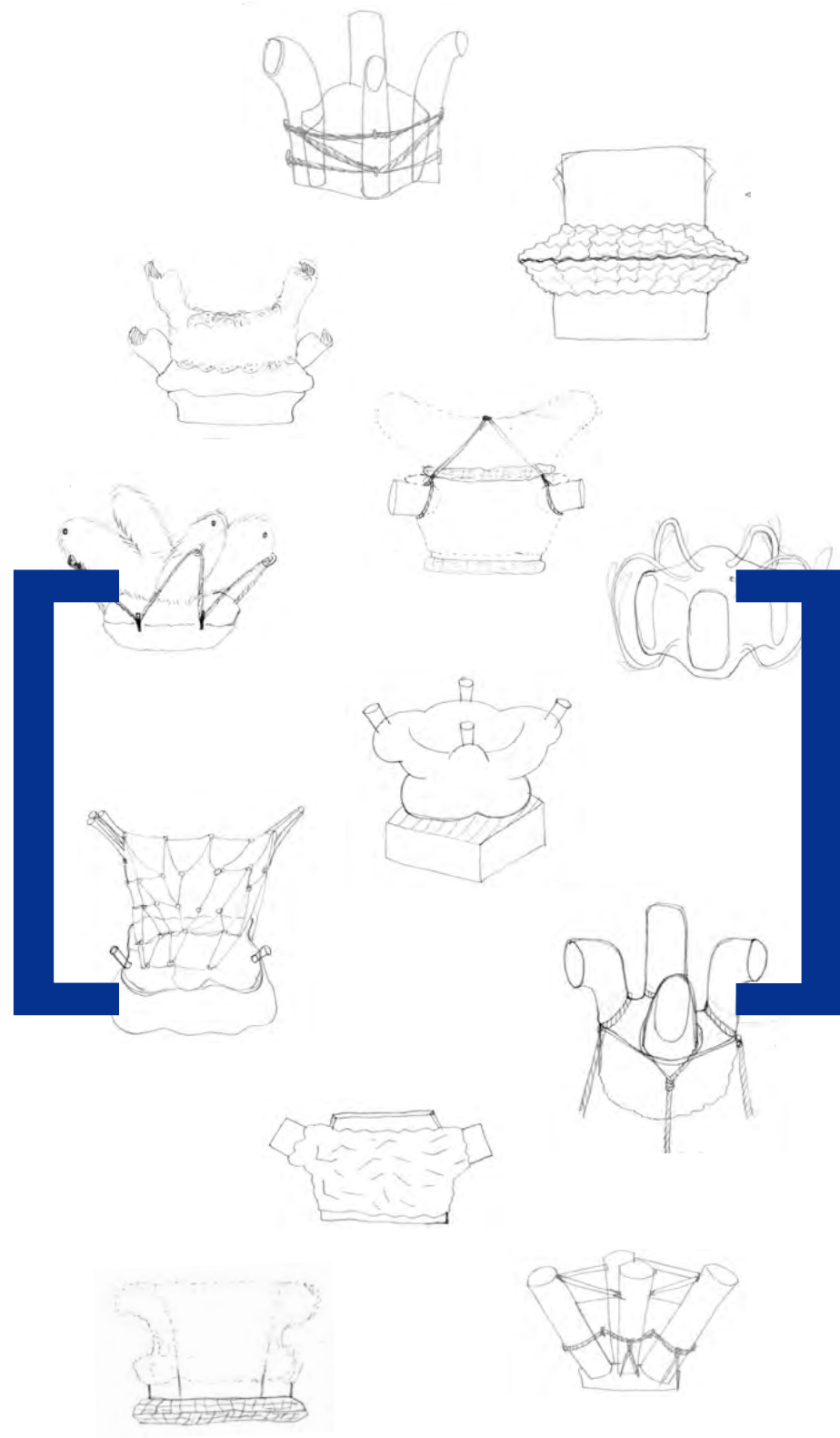

Conclusion

This thesis started with questioning myself as a Chinese designer. By researching the historical, political, economic and cultural reasons behind the phenomenon of copying, I found that the identity of Chinese design is rooted in a long history of cultural exchange between China and the rest of the world. In the process cultures borrow from each other and transform these borrowings along the way. There is no 'pure' or 'specific' Chinese identity in design. The identity of design develops in the process of copying and being copied. In other words, because of copying and transformation, designs are hybrids between cultures.

I have found through this research that copying is a composite process, and my design attempts to present the complicated relationship between original and copy. As we have seen in my research, the identities of original and copy have been blurred in the transformation—the process of copying. Copy doesn't happen in a single-treaded way—between the original creators and imitator—but sometimes it can be in an opposite way. For example the Dutch potters were the initial imitators of the Nanjing Pagoda, but later when the Chinese were commissioned to reproduce the Tulip Pyramid, they became the imitator. The original itself can consist of different original designs, and it can even be copied to improve on its initial design, as we have seen with the example of the two sim-card cellphone, which was later implemented in the original design by Samsung. Even though every designer is confronted with the possibility and probability of being copied, my claim is that being copied stimulates innovative designs.

The collective Tulip Pyramids will contain new copyrights. What shall we do if someone else copies the work afterwards? Of course, I am concerned with the Intellectual Property of our works. However, at the same time, I would like to see how people 'steal' our ideas. From my perspective, I am not worried about people maliciously copying my project, because, for one, I think my design is unlikely to be copied as a whole since it is not a functional object for 'instant' use. The vase is a type of semi-functional object, which many designers took as a carrier of statements. Secondly, it is a very complicated project - with 6 participants' skills and experiences—which makes it very difficult to be copied or make sense as a whole in different contexts other than my research.

Moreover, what will happen after my graduation—such as the pyramids being borrowed or appropriated—is part of the transformation. I would like to generate a natural process of copying as a way to fuel the project itself. This project called for only one action: copy. Therefore, all of the six participating designers are the first degree of copying. When people start to borrow or appropriate one or some of the ideas in this project, since they are doing the same thing as we six participants did, they immediately become part of the project in a second degree, and so on. In this way, every posture of copying to this project itself turning it into an on-going, infinitive project.

From a personal perspective, I am curious to see how people will make use of the potentials in this project. IP law cannot stop creative ideas from influencing one another, and it wouldn't stop copying as a learning process. And so, instead of building a higher wall to defend myself from being copied, I would rather learn how others borrow or shape my ideas. I believe learning from copying benefits my future works. I hope the project can work as a self-perpetuating machine; continuously generating possibilities, discussions and opportunities. I believe copying will not choke creativity; quite the opposite, copying can stimulate creativity and drive new ways of exploring themes in design.

Appendix

Misunderstanding and errors

Errors are caused for many reasons. First, they can be caused by low quality control during manufacturing. There were two categories of porcelain kilns in ancient China, the imperial ones and the private ones. The palace and royal families primarily used imperial kilns, and they only produced high quality porcelain objects in small amounts. The private porcelain kilns are similar to contemporary factories; the products they produced were sold to common people, or exported. According to the book *Ten Thousand Things* (1998) by Lothar Ledderose (b.1942), sometimes the imperial and private kilns collaborated for economic reasons. These collaborations and their customers were not as strict as the imperial ones. For instance, the porcelain made in China in the exhibition *Asia > Amsterdam* was from private kilns, which mass-produced porcelain from 16th century on. Second, it can be caused by misunderstandings between cultures. In the private kilns, potters worked in a way similar to the assembly line nowadays. They were skillful in the things they were familiar with. In her research, Teresa Canepa concludes, ‘The indirect nature of those orders, now placed via the Chinese Junk traders that frequented Macau, is reflected in the errors made by the Jingdezhen painters in the execution of European motifs that were unfamiliar to them...These painters...continued to create hybrid decorations... in combination with a variety of religious auspicious motifs with Taoist, Buddhist and Confucian connotations.’

Although Teresa Canepa didn’t explain how the errors happened in detail, I believe her description supports my hypothesis.

With regards to the motifs in the charger porcelain plate, I can not find exactly the same images and creatures in history. But I did look at other art works/objects from the same era, and I concluded that the motifs didn’t come out of the blue. [fig.11.p.33](#) I think the Portuguese probably commissioned the charger plate, because they used a similar theme with the carvings on the Ruins of St. Paul’s in Macau. The Portuguese clients gave these designs to the Chinese potters, who instead used their own style in the final execution (probably based on a misunderstanding). It is unclear if these errors were made on purpose or not.

What is the original motif of a seven headed creature?

What did the Europeans order from the potters in Jingdezhen? As I mentioned earlier, the motifs of seven-headed creatures on the plate could relate to the Portuguese, though the reason and meaning of the combination of hydra and wyvern are unclear. I came up with the two following hypotheses: 1. It could be that the images are of Margaret the Virgin escaped from the dragon, because it looks like her body is attached to the dragon’s. [fig.50-51.p.80](#) 2. The image is the same as the carving in the Ruins of St. Paul’s; Margaret the Virgin stands on the top of a dragon. In the motif, the creature has two human heads—one woman and one man. From a purely visual perspective, the dragon (or devil) in the carving from St. Paul’s (Macau) is very human-like. The motifs evoke two ways of recognition. First, by intuition based on my knowledge in a visual sense, and a rational way based on the meaning of these motifs. I try to imagine what I would see in the motifs if I were a potter in Jingdezhen 400 years ago.

Two ways of recognition

Generally, we only see the things we already know; we cannot see beyond our knowledge of images and symbols. In the visual sense, I believe that potters would relate the Catholic images to the figures in traditional Chinese culture. What is interesting is that this might be considered a strategy for preaching, like the function of the carving in the Ruins of St. Paul’s. However, the potters saw them in an unexpected way. Whatever the original image was, when I saw one man and one woman with long and soft necks, it reminded me of two figures in Chinese mythology: Nüwa (女媧) and her husband/brother Fuxi (伏羲) from Chinese mythology. [fig.52.p.80](#) They both have human heads and snake bodies. Nüwa was created from clay at the dawn of the world, and fixed a hole in the sky to save all lives on earth. She and her brother Fuxi are the first humans ever to be wed. In folklore imagery, their bodies are intertwined, symbolizing reproduction. These stories probably were common knowledge for Chinese people in the 17th century. But what if the potters knew the stories about hydra, Margaret and the dragon, and Guanyin training the dragon? All these stories are about defeating evil. The hydra originated from Greek and Roman

mythology, it was the guard of Lake Lerna, the entrance to the Underworld. Heracles and his nephew Lolaus cut off its seven heads. [fig.15.p.36](#) According to The Continuum Encyclopaedia of Symbols (2000), ‘The hydra is a symbol of difficulties and obstacles that proliferate in the course of accomplishing a task.’ Similar figures and stories are recorded in an ancient Chinese book *Classics of Mountains and Seas* or *Shan-hai Ching* (4th century B.C.), in which 277 imaginary creatures are recorded. Besides Nüwa and Fuxi, some of them have human heads with snake-bodies. In one of the stories about defeating evil, a nine-headed snake named Xiang Liu (相柳) was killed by a hero named Yu the Great (2200–2100 B.C.) to control the threat of a flood [fig.54](#). Is it possible that Chinese potters drew two heads of Xiang Liu into a hydra’s body?

I tend to believe that, these potters had misunderstood the original images in a visual sense. First, the private kilns were not strict about the meanings of these motifs. There is an example of how potters treated the motifs they didn’t understand in the book *Ten Thousands Things*, ‘Yet the Chinese designer apparently was not sure what the church spires in the background were for, so, to be on the safe side, he hid two more of them in the foreground grass.’ [fig.55](#) This plate was made in 1700, much later than the pseudo-armorial plate, I think that this sort of problem had existed earlier already. And ‘to be on the safe side’ is an interesting description; ‘to be safe’ means to make the strangeness familiar, instead of the uncomfortable feeling of confronting the unfamiliar things, or to pretend to understand.

Copies bring out the original

It is hard to define what is original in this pseudo-armorial motif, or, is it an original itself? Its source and meaning are unclear, it maybe an imitation of symbols or figures from different cultures, and it may contain errors. But once it had been copied, relative to its copies, it had the identity of ‘original’.

There are several copies of this pseudo-armorial. Three of them were copied by Iranian craftsmen in the 17th century and are part of the collection of the Victoria and Albert Museum (UK). One bowl has the same shape and similar motifs with the bowl in Willem ClaeszHeda’s

painting; however, its Latin motto became meaningless graphics. [fig.14.p.36](#)

The museum’s description reads, ‘The Iranian potter faithfully imitates the design, but the inscription is completely illegible as it was in a foreign script.’ To verify its description, I consulted researchers who are familiar with Iranian culture, and their answers are the same as V&A’s description. Why didn’t the Iranian potters copy the letters, to the letter? Maybe they didn’t copy it directly from the original, or they didn’t understand that the Latin motto was a language, or they didn’t want to spread the information from the motto. Whatever the reason may be, in the end they turned the Latin motto into just forms. The motifs in the other two objects seem to illustrate the process of the original Latin motto becoming more and more abstract, and end up as decorative lines. Perhaps for the Iranian potters, who had no affinities with European and Chinese culture, they saw them as a wholly exotic imagery. ‘This bowl is an important document in the history of international trade, evidence that a design made for one customer could be copied and sold to others of different nationalities.’ Beside this description from the museum, the changing of these motifs on those objects also documented a change from function to decoration - the preaching of religion and morality gradually turns into a simple exotic image.

To sum up, the imperfect copies and errors during the production process were not solely mistakes; they reflected the different values and intentions behind makers or designers’ decisions based on their own culture.

Bibliography

Books

Boon, Marcus. *In Praise of Copying*, (Harvard University Press, 2010).

Bourriaud, Nicolas. *Postproduction*, (Lucas & Sternberg, 2007).

Ledderose, Lothar. *Ten Thousand Things: Module and Mass Production in Chinese Art*, (Princeton University Press, 2001).

Lambody, Suzanne. *Imitation and Inspiration: the artistic rivalry between Dutch delftware and Chinese porcelain, Chinese and Japanese porcelain for the Dutch Golden Age*, edited by Jan van Campen and Titus Eliens, (Uitgeverij De Kunst, 2014).

Scholten, Frits. *Rijksmuseum Delft 'Tulip Vases'*, (Rijksmuseum, 2013).

Canepa, Teresa. *Silk, Porcelain and Lacquer: China and Japan and their trade with Western Europe and the New World 1500-1644. A Survey of Documentary and Material Evidence*, (Universiteit Leiden, 2015).

Inoue, Tatsuhiko. *Good Imitation to Great Innovation (模仿的技术:企业如何从"山寨"到创新)*. Translated by Xing Yuan (兴远), World Books Publishing, 2014

Internet References

Morris, Ruth. *Why China loves to build copycat towns*, bbc.com, 1 July 2013.

Schuman, Michael. *Why Alibaba's Massive Counterfeit Problem Will Never Be Solved*, forbes.com, 4 November 2015.

Ma, April. *China prepares for Singles Day counterfeits*, ft.com, 10 November 2015.

Copyleft Appropriation Art in China, powerstationofart.com, 2015.

Erlhoff, Michael. *China and the Bauhaus as a cabinet of curiosities*, stylepark.com, 11 December 2011.

Li, Bin (李彬). '中国代工工厂末路悲歌', businessleaders.com.cn, 11 September 2012.

Liu, Libin (刘礼宾). '谁还愿意成为"挪用艺术"的代表?', review.artintern.net, 19 August 2015.

Sun, Linlin (孙琳琳). '包豪斯对杭州有什么用', newweekly.com, 2012.



fig.49
Details of the stone facade
Ruins of St. Paul, built from
1582-1602, Macau



fig.50
Sainte Marguerite d'Antioche,
c.1475



fig.51
Detail of Traduction française
par Jean de Vignay de la
Légende dorée de Jacques
de Voragine, c.1365-1375,
Bibliothèque Mazarine



fig.52
Nüwa and Fuxi, painting on the
silk, Tang Dynasty, 618-907A.D.



fig.53
Beham, (Hans) Sebald (1500-
1550): Hercules slaying the Hydra,
1545 (B.102, P.100 iv/iv) from *The
Labours of Hercules* (1542-1548).

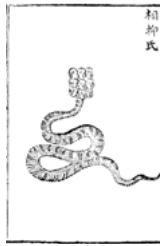

fig.54
Illustration of Xiang Liu in
Shan-hai Ching



fig.55
Illustration from Ten Thousand
Things, Chinese plate in
Delft, c.1700-25, Porcelain,
Formerly Mottahedeh Collection

Credits

Tulip Pyramid—Copy and Identity

Author

Jing He fig.55

This text was originally written as a thesis report for a research project concerning copying and cultural identity, and accompanied the design project Tulip Pyramid. Both the design project and the thesis were part of Jing's graduation from Contextual Design (MA) at Design Academy Eindhoven in 2016.

Co-creators of the tulip pyramid

Rongkai He, Cheng Guo, Weiyi Li, Dangdang Xing, Dawei Yang

Thesis mentor

Koen Kleijn

Design mentors

Gijs Assmann, Maarten Baas, Simone Farresin, Mikel van Gelderen, Hewald Jongenelis, Jan Konings, Karel Martens, Vincent de Rijk, Louise Schouwenberg (head of Contextual Design department)

Editor of the final text

Ben Shai van der Wal

Photographer

Femke Reijerman

Graphic designer and illustration

Yoko Wong Chor Kiu

Graphic design advisor

Joost Grootens

Printing

UNICUM | Gianotten Printed Media, Tilburg, The Netherlands

Paper

Cyclus Offset, 90 & 350gsm

Typeface

Altas Grotesk & Lyon by *Commercial Type*

Coordinator on behalf of Design Academy Eindhoven

Gabrielle Kennedy

Published by

Design Academy Eindhoven

Jing He would like to specially thank the following people

Without Gabrielle Kennedy and Yoko Wong Chor Kiu's tireless efforts, this publication would not have been possible; Lide He and Xuhui Mao for your support during my study time; Zhi Li for your patience and for reading the text and helping me to improve during the writing process; Noon Passama for your support during my graduation; and finally I want to thank all the designers I collaborated with: I am grateful for your talents and your willingness to participate in this project.

No part of this publication may be reproduced or transmitted in any form or by any means without prior permission from the publisher.

© Jing He, 2016

This publication was funded by Design Academy Eindhoven.



fig.55

About the author:

Jing He was born in Kunming, China in 1984. She is a designer and graduated *cum laude* from the Contextual Design department (MA), Design Academy Eindhoven (NL) in 2016. She received her Design (BA) degree from Gerrit Rietveld Academie (NL) in 2013 and Central Academy of Fine Arts (CN) in 2007.

www.he-jing.com

This publication is part of the Design Academy Eindhoven's Dialogue programme and is the first in a new series, 'The Academy Collection' which will unlock and celebrate excellent research for a broader audience.

My research began, like many do, with a question concerning my identity. As a Chinese designer, I am frequently asked whether my work reflects my Chinese identity. And I wonder what does that mean? What is Chinese design? And in what way does it differ from other nationalities? I explore the intentions behind these questions and I describe how Chinese designers are anxious about their identity, and, as one of them, I share this anxiety.

I believe that one's identity reflects where and how one was raised. I want to learn from the phenomenon of copying in China, instead of denying it. I aim towards a design methodology inspired by the practice of copying in Chinese culture. By researching the historical, political, economic and cultural reasons behind the phenomenon, I found that the identity of Chinese design is rooted in a long history of copying and transformation, or cultural exchange between China and the rest of the world. In this process culture is borrowed and transformed along the way. There is no 'pure' or 'specific' Chinese identity in design. Rather, the identity of Chinese design developed through this process of copying and being copied. In other words designs are hybrids between different cultures.

FRONT
BACK

Tulip Pyramid, Jing He, 2016, Design Academy Eindhoven
Tulip Pyramid, The Metal Pot to Lambertus van Een hoorn, c.1692-1700, Rijksmuseum

